

LCD-APK23 Professional and Versatile 23" LED Monitor

4K UHD



Key Benefits

- ▶ 23" LED, 3840 x 2160 native UHD resolution
- ▶ 1920 x 1080 & 1920 x 1200 resolution support
- ▶ 1.07 billion colors (10-bit) / 310 cd/m² brightness
- ▶ PIP Sub-screen & PBP Dual-screen viewing efficiency
- ▶ Display port 1.2 + HDMI 1.4 + HDMI 2.0 video input
- ▶ Video decoding capability up to 1080p (option)
- ▶ Rugged structure ensures high mobility
- ▶ IP65 front protection (NAP series)
- ▶ Professional-use durability & around-the-clock operation
- ▶ 2-year standard warranty (upgradable up to 5 years)

Applications

- Broadcasting / Advertising
- Traffic control / Command center
- Directory / Ticket kiosk
- Surveillance system
- Vehicle mount display
- Bathroom TV

The Industrial series 23" 4K UHD LED monitor supports 3840 x 2160 resolution, 4 times the resolution of FHD. True 10-bit input enables 1.07 billion colors to be presented, achieving ultimate picture quality. Improved energy efficiency and fan-less architecture provides professional-use durability and around-the-clock operation.

K23 is more than just a standalone monitor. It has a variety of embedded modules including HDMI Decoder, HDMI Extender, HDMI Quad display Extender, Multi-Monitor OSD Controller, SDI Input and Portrait Mode Kit. The embedded modules give you the ability of video remote management and transmission for multiple monitors over network.

As a versatile 4K monitor, K23 is meticulously designed to meet professional and environmental demands including IP 65 Front protection, Multi-touch, Anti-reflective/Vandal proof glass, DC power input, Brightness dimming and Mounting kit for Panel-mount, VESA-mount, Universal-mount and Desktop stand.

With over 22 years' production experience, the K23 structure is well-engineered and manufactured by our own CNC facilities and team of experts to ensure its ruggedness, mobility and quality, as well as being suitable for harsh environment applications. The structure can be customized if required to facilitate monitor installation. Our knowledgeable engineers are able to provide frame customization for specific dimensions, color, metal treatment, screen printing, bezel and mounting.

Options

Video Management & Transmission over Network

- Embedded HDMI Decoder Module 1080p over IP
- Embedded HDMI Extender Module 1080p over network
- Embedded HDMI Quad Display Module 1080p over network
- Embedded HDMI Quad Display Extension Module
- Embedded Multi Monitor OSD Control Module over serial
- Embedded 3G / HD / SD-SDI Input Module
- Embedded Portrait Mode Module
- Embedded Brightness Dimming Module

Bezel & Frame Customization

- Dimension
- Color & Treatment
- Screen Printing
- Stainless Steel Bezel

Touchscreen & Glass Protection

- Projected Capacitive 10-point Touch
- Infrared 6-point Touch
- 5-Wire Resistive 1-point Touch
- Anti-reflective Glass
- Vandal Proof Glass

DC Power

- 12V / 24V / 48V / 125VDC (100 Watt)

Mounting

- VESA mount, 100 x 100mm (bundled)
- Universal mount (bundled)
- Desktop stand (option)
- Panel mount (bundled)

6mm aluminum front bezel



AP-K23

6mm aluminum front bezel
NEMA 4 / IP65 front protection



NAP-K23

Aluminum front cover



DP-K23

Universal open frame



OP-K23

Diagrams (mm)

Front View

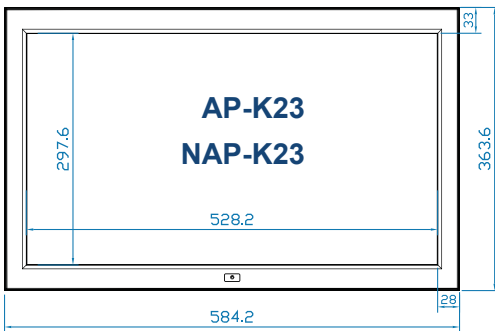

Side View

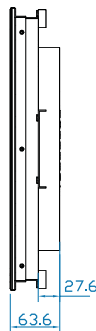

Rear View

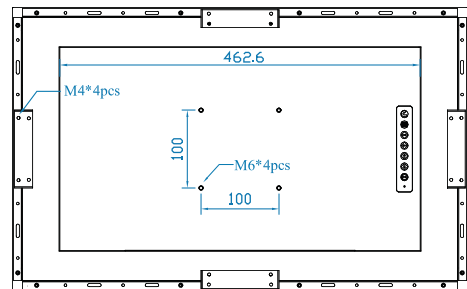

Front View

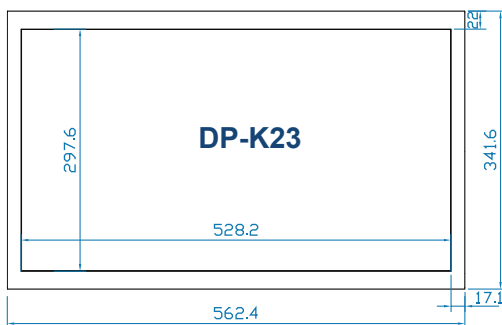

Side View

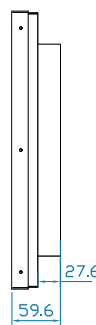

Rear View

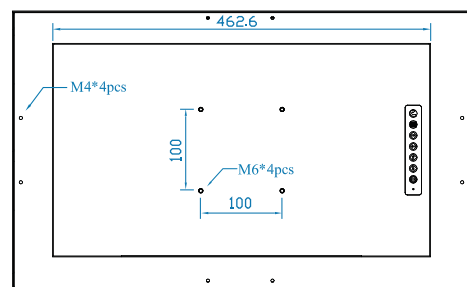

Front View

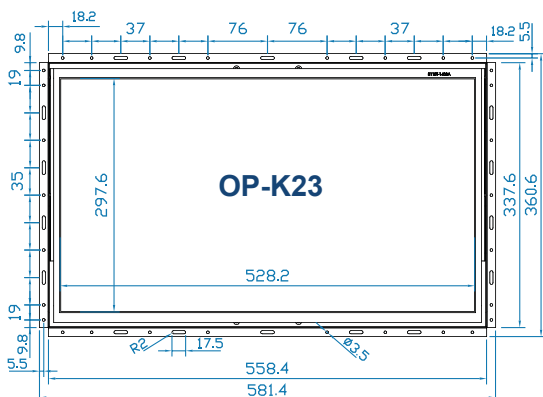

Side View

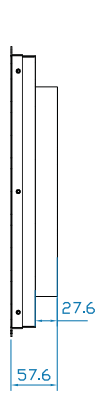

Rear View

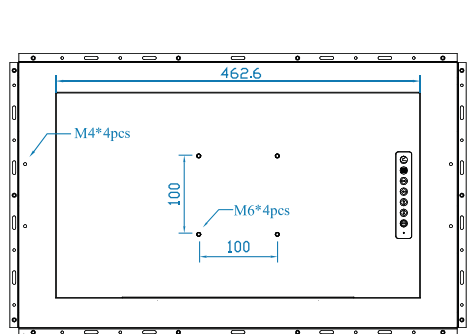

Options — Video Management & Transmission over Network

Embedded HDMI Decoder Module 1080p over IP

- Decodes RTSP, RTMP, UDP, HTTP, HLS protocols
- Supports video resolutions up to 1080p / 60Hz
- Unicast and multicast support
- Operates on standard 1000Mb Ethernet networks
- Built-in Web UI for configuration and control
- Excellent image quality with very low delay

K23 w/ decoder



K23 w/ decoder

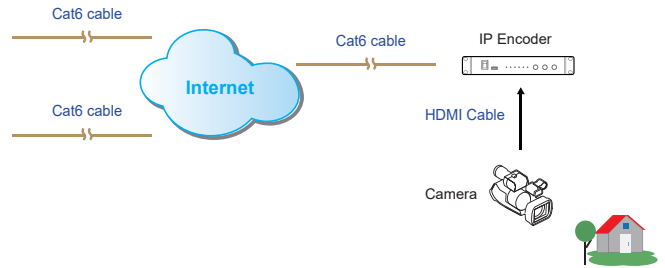

Part no.

Embedded HDMI Decoder Module : **UV-DE100F**

Standalone HDMI Encoder : **UV-EN100F**

Embedded HDMI Receiver Module 1080p

- Extends the HDMI signal over a single Cat5/6 cable
- Supports video resolutions up to 1080p / 60Hz
- One to one just via Cat5/6 cable
- One to multi via network hub and Cat5/6 cable
- 100m maximum Cat5/6 cable distance
- Supports bi-directional IR communication
- High Speed HDMI 1.3 and HDCP 1.1 compliant
- No software or drivers required

K23 w/ receiver



K23 w/ receiver



Up to 250 monitors

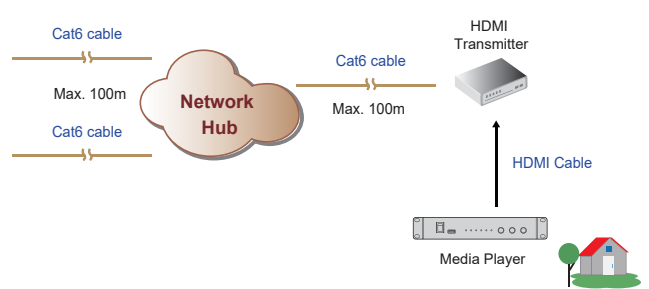

Part no.

Embedded HDMI Receiver Module : **UV-R100F**

Standalone HDMI Transmitter : **UV-T100F**

Embedded HDMI Quad Display Module 1080p

- Allows 4 x HDMI inputs to be monitored simultaneously
- Quad split, panel left and full screen monitoring modes
- High speed HDMI 1.3a and HDCP 1.2 compliant
- Supports video resolutions up to 1080p / 60Hz
- Supports Scaler Up and Down function
- Control via local front panel and IR remote

K23 w/ Quad Display

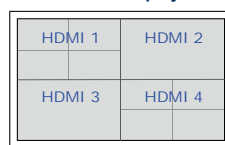

K23 w/ Extension Module

Cat6 cable
Max. 50m

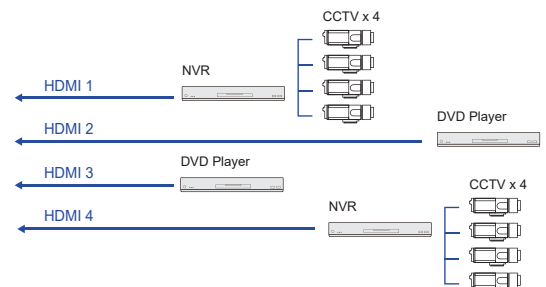

Part no.

Embedded HDMI Quad Display Module : **QD-1080**

Embedded Quad Display Extension Module : **QD-E1080**

Options — Video Management & Transmission over Network

Embedded Multi Monitor OSD Control Module over serial

- Remote control the monitor OSD via RS-232C serial interface
- Daisy chain up to 64 monitors via Cat5/6 cable
- Individual ID for individual monitor OSD settings
- Power ON or OFF monitor
- Adjust brightness & audio
- Switch video sources

Up to 64 monitors
Up to 1,000m distance

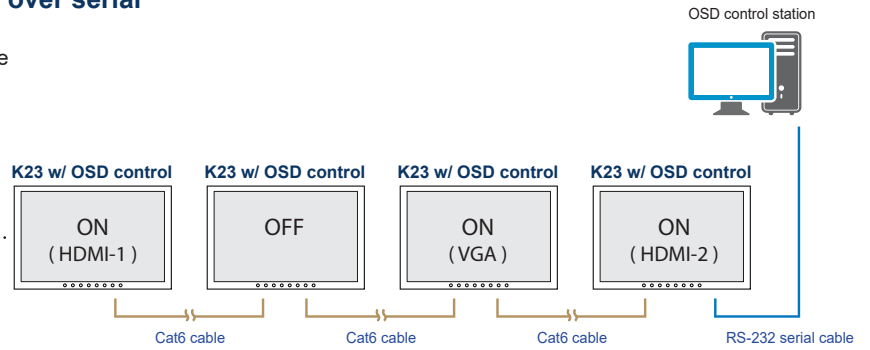

Part no.

Embedded Multi Monitor OSD Control Module : **MCS**

Embedded 3G / HD / SD-SDI Input Module

- Intelligent SDI monitoring with broadcast quality scopes
- Supports multi-rate 3G / HD / SD-SDI format
- Provides input to output loop-through capability
- Auto format sensing & selection

Part no.

Embedded 3G / HD / SD-SDI Input Module : **SDI**

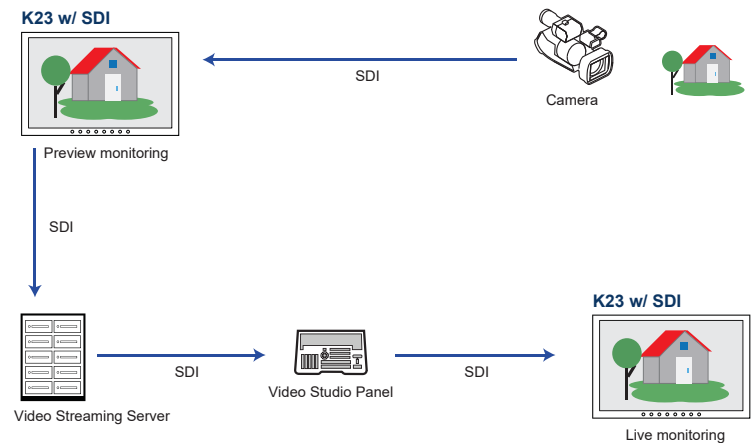

Embedded Portrait Mode Module

- Provides users with a rotation feature (0, 90, 180 & 270 orientation) without frame delay via OSD
- Allows distortion-free display of content in various orientations
- Creates new application opportunities



K23
w/ Portrait mode module

Part no.
Embedded Portrait Mode Module : **AD4.0-P**

Embedded Auto Brightness Dimming Module

- Brightness changes according to its ambient brightness
- Its brightness change causes 10% increase or decrease

Part no.

Embedded Brightness Auto Dimming Module : **DA-01**

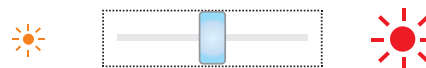

Embedded Manual Brightness Dimming Knob

- Easy-to-use IP54 dimming knob on the front panel
- One click causes 2% brightness increase or decrease
- Brightness adjustment from 0% to 100%

Part no.

Brightness Dimming Knob : **DS-01**

Option — e-Resistive 1-point Touch

| | TRB e-Resistive |
|--------------------|------------------------------|
| Technology | 5-Wire Resistive |
| Touch Point | Single |
| Input Type | Finger or Stylus |
| Resolution | 2048 x 2048 |
| Response Speed | 15 ms |
| Activation Force | ≤ 50 g |
| Surface Hardness | 3H |
| Light Transmission | 80% ± 3% |
| Haze | 8% ± 3% |
| Durability | 10 million touches |
| Top Layer | ITO Film |
| Bottom Layer | ITO Glass |
| Thickness | 2.2 ± 0.2 mm |
| Connector | USB Type A |
| Compatibility | Windows 7 / XP / Linux / Mac |

Part no. : K23TRB

** Dimension will be changed if multi-touch required

Option — Projected Capacitive 10-point Touch

| | TPC-10 Multi-touch |
|----------------------|---|
| Technology | Projected Capacitive |
| Touch Point | 10 point touch standard (special requirement available) |
| Input Type | Finger or Capacitive Stylus |
| Resolution | 4096 x 4096 |
| Touch Point Accuracy | ± 2 mm |
| Response Speed | < 5 ms |
| Activation Force | < 5 g |
| Surface Hardness | 6H |
| Light Transmission | > 85% |
| Haze | 3%↓ |
| Durability | 50 million touches |
| Top Layer | 3 mm Glass |
| Bottom Layer | 0.7 mm Sensor Glass |
| Thickness | 3.9 ± 0.1 mm |
| Connector | USB |
| Compatibility | Windows / Linux / Android / Mac |

Part no. : K23-TPC10

** Dimension will be changed if multi-touch required

Option — Infrared 6-point Touch

| | IR6 Infrared |
|----------------------|---|
| Technology | Infrared |
| Touch Point | 6 |
| Input Type | Pen, Finger, Finger of gloved hand activation |
| Touch Point Accuracy | ± 2 mm |
| Response Speed | ≤ 8 ms |
| Activation Force | No minimum touch activation force |
| Touch Durability | Unlimited |
| Glass Thickness | 2 mm |
| Connector | A-type USB |
| Operating System | Windows 7 / Windows 10 |

Part no. : K23-IR6

** Dimension will be changed if multi-touch required

Options — DC Power

| | | 12V | 24V | 48V | 125V |
|---------------|----------------|---------|----------|----------|-----------|
| Input rating | Input voltage | 12-Volt | 24-Volt | 48-Volt | 110-Volt |
| | Input range | 9 ~ 18V | 18 ~ 36V | 36 ~ 75V | 66 ~ 160V |
| Input current | No load | 50 mA | 50 mA | 50 mA | 35 mA |
| | Full load | 7183 mA | 3551 mA | 1755 mA | 749 mA |
| Output rating | Output voltage | 12-Volt | 12-Volt | 12-Volt | 12-Volt |
| | Output current | 6.25A | 6.25A | 6.25A | 6.25A |
| Efficiency | | 87% | 88% | 89% | 91% |

Part no. : 12VDC
24VDC
48VDC
125VDC

Product Specifications

| LCD Panel | |
|---------------------------------|----------------------------------|
| Panel size (diagonal) | 23-inch widescreen TFT color LCD |
| Native resolution | 3840 x 2160 |
| Brightness (cd/m ²) | 310 |
| Contrast ratio (typ.) | 1000 : 1 |
| Colors | 1.07 Billion, 10-bit |
| Viewing angle (L/R/U/D) | 89/89/89/89 |
| Response time (ms) | 25 |
| Dot pitch (mm) | 0.13725 |
| Display area (mm) | 527.04H x 296.46V |
| Surface treatment | Anti-glare |
| Surface hardness | 3H |
| Backlight type | LED |
| MTBF (hrs) | 30,000 |

| Video | |
|--------------|--|
| Digital : | |
| Display port | DP 1.2 / HDCP 1.3 |
| HDMI | HDMI 2.0 / HDCP 2.2 HDMI 1.4 / HDCP 1.4 |

| Audio | |
|--------------------------|-------------------|
| Audio input : | |
| Connector | 3.5mm stereo jack |
| Impedance / Power level | 30kΩ / 750mV |
| Audio output : | |
| Connector | 3.5mm stereo jack |
| Resistance / Power level | 30kΩ / 2.8V |
| Speaker : | |
| Dual stereo speaker | 2W x 2 |

*When the audio output is connected, speaker output is OFF

| Power | |
|-------------------|---------------------------------------|
| Input | Auto-sensing 100 to 240VAC, 50 / 60Hz |
| Consumption : | |
| Screen on | Max. 45W |
| Power saving mode | Max. 9W |
| Power button on | Max. 2W |

| Environment | |
|------------------------|------------------------------------|
| Operating temp. | 0 to 55°C degree |
| Storage temp. | -20 to 60°C degree |
| Operating humidity | 20~90%, non-condensing |
| Storage humidity | 5 ~90%, non-condensing |
| Operating altitude | 16,000 ft |
| Non-operating altitude | 40,000 ft |
| Shock | 10G acceleration (11ms duration) |
| Vibration | 10~300Hz 0.5G RMS random vibration |

| Design | AP-K23 | NAP-K23 | DP-K23 | OP-K23 |
|-------------|-----------------|---------------|-------------|------------|
| Protection | 6mm front bezel | NEMA 4 / IP65 | front cover | open frame |
| Front panel | Black, RAL 9005 | | | - |
| Rear casing | Black, RAL 9005 | | | |

| Mounting | AP-K23 / NAP-K23 | DP-K23 | OP-K23 |
|-----------------|------------------|--------------|--------------|
| VESA mount | 100 x 100 mm | 100 x 100 mm | 100 x 100 mm |
| Universal mount | - | - | bundled |
| Desktop stand | option | option | - |
| Panel mount | bundled | bundled | - |

| Physical | AP-K23 / NAP-K23 | DP-K23 | OP-K23 |
|-----------------------|----------------------|----------------------|----------------------|
| Product (W x D x H) : | | | |
| mm | 584.2 x 63.6 x 363.6 | 562.4 x 59.6 x 341.6 | 581.4 x 57.6 x 360.6 |
| inch | 23 x 2.5 x 14.3 | 22.1 x 2.3 x 13.4 | 22.9 x 2.3 x 14.2 |
| Packing (W x D x H) : | | | |
| mm | 659 x 117 x 640 | 659 x 117 x 640 | 659 x 117 x 640 |
| inch | 25.9 x 4.6 x 25.2 | 25.9 x 4.6 x 25.2 | 25.9 x 4.6 x 25.2 |
| Net weight | 9 kg / 19.8 lb | 9 kg / 19.8 lb | 7.9 kg / 17.4 lb |
| Gross weight | 12.7 kg / 27.9 lb | 12.7 kg / 27.9 lb | 11.6 kg / 25.5 lb |
| Chassis color | dark | | |
| Chassis materials | Aluminum | | |

| Compliance | |
|-------------|-------------------------|
| EMC | FCC & CE certified |
| Safety | CE / LVD certified |
| Environment | RoHS2 & REACH compliant |

| Applicable Format | | |
|--------------------|----------------|--|
| Display port input | PC signal | 3840 x 2160 x 60Hz 1920 x 1080 x 60Hz 1600 x 1200 x 60Hz 1360 x 768 x 60Hz 1280 x 1024 x 60 / 75Hz 1280 x 768 x 60Hz 1024 x 768 x 60 / 70 / 75Hz 800 x 600 x 60 / 72 / 75Hz 720 x 400 x 70Hz 640 x 480 x 60 / 72 / 75Hz |
| | Audio signal | 2ch Linear PCM |
| HDMI input | HDMI 2.0 | 3840 x 2160 x 60 Hz |
| | HDMI 2.0 / 1.4 | 3840 x 2160 x 30 Hz 1920 x 1080 x 50 / 60Hz (1080p) 1920 x 1080 x 25 / 30Hz (1080i) 1280 x 720 x 50 / 60Hz (720p) 720 x 480 x 50 / 60Hz (576p / 480p) |
| | | Audio signal |

The Industrial series covers a full range of professional LCD display sizes from 6.5" to 65". Please select from the below the most suitable model for your application.

Sales Inquiry

sales@austin-hughes.com

Technical Support

sales@austin-hughes.com

16 : 9

(4K / 1080p)

- K65"
- K55"
- K43"
- K32"
- K28"
- K23"
- K17"
- K15"

16 : 9

(1080p)

- F21"
- F17"
- F15"

16 : 10

- X24" (1920 x 1200)
- X17" (1920 x 1200)
- W19" (1440 x 900)

4 : 3

- 20" (1600 x 1200)
- 19" (1280 x 1024)
- 17" (1280 x 1024)
- 15" (1024 x 768)
- 12" (800 x 600)
- 10" (800 x 600)
- 8" (800 x 600)
- 6" (640 x 480)

Sunlight Readable



16 : 9

(4K / 1080p)

- K65"
- K55"
- K43"
- K32"

16 : 9

(1080p)

- F21"
- F17"

16 : 10

- W19" (1440 x 900)

4 : 3

- 19" (1280 x 1024)
- 17" (1280 x 1024)