

4K UHD



Key Benefits

- ▶ 28" LED, 3840 x 2160 native UHD resolution
- ▶ 1920 x 1080 & 1920 x 1200 resolution support
- ▶ 1.07 billion colors (10-bit) / 300 cd/m² brightness
- ▶ PIP Sub-screen & PBP Dual-screen viewing efficiency
- ▶ Display port 1.2 + HDMI 1.4 + HDMI 2.0 video input
- ▶ Video decoding capability up to 1080p (option)
- ▶ Rugged structure ensures high mobility
- ▶ IP65 front protection (NAP series)
- ▶ Professional-use durability & around-the-clock operation
- ▶ 2-year standard warranty (upgradable up to 5 years)

Applications

- Broadcasting / Advertising
- Traffic control / Command center
- Directory / Ticket kiosk
- Surveillance system
- Vehicle mount display
- Bathroom TV

The Industrial 28" 4K UHD LED monitor supports 3840 x 2160 resolution, 4 times the resolution of FHD. True 10-bit input enables 1.07 billion colors to be presented, achieving ultimate picture quality. Improved energy efficiency and fan-less architecture provides professional-use durability and around-the-clock operation.

K28 is more than just a standalone monitor. It has a variety of embedded modules including HDMI Decoder, HDMI Extender, HDMI Quad display Extender, Multi-Monitor OSD Controller, SDI Input and Portrait Mode Kit. The embedded modules give you the ability of video remote management and transmission for multiple monitors over network.

As a versatile 4K monitor, K28 is meticulously designed to meet professional and environmental demands including IP65 Front protection, Multi-touch, Anti-reflective/Vandal proof glass, DC power input, Brightness dimming and Mounting kit for Overhead tilted wall-mount, Panel-mount, VESA-mount, Universal-mount and Desktop stand.

With over 22 years' production experience, the K28 structure is well-engineered and manufactured by our own CNC facilities and team of experts to ensure its ruggedness, mobility and quality, as well as being suitable for harsh environment applications. The structure can be customized if required to facilitate monitor installation. Our knowledgeable engineers are able to provide frame customization for specific dimensions, color, metal treatment, screen printing, bezel and mounting.

Options

Video Management & Transmission over Network

- Embedded HDMI Decoder Module 1080p over IP
- Embedded HDMI Extender Module 1080p over network
- Embedded HDMI Quad Display Module 1080p over network
- Embedded HDMI Quad Display Extension Module
- Embedded Multi Monitor OSD Control Module over serial
- Embedded 3G / HD / SD-SDI Input Module
- Embedded Portrait Mode Module
- Embedded Brightness Dimming Module

Bezel & Frame Customization

- Dimension
- Color & Treatment
- Screen Printing
- Stainless Steel Bezel

Touchscreen & Glass Protection

- Projected Capacitive 10-point Touch
- Anti-reflective Glass
- Vandal Proof Glass

DC Power

- 24V / 48V / 125VDC (100 Watt)

Mounting

- VESA mount , 100 x 100mm (bundled)
- Universal mount (bundled)
- Overhead tilted wall-mount (option)
- Desktop stand (option)
- Wall mount (bundled)

6mm aluminum front bezel



AP-K28

6mm aluminum front bezel
NEMA 4 / IP65 front protection



NAP-K28

Aluminum front cover



DP-K28

Universal open frame



OP-K28

Diagrams (mm)

Front View

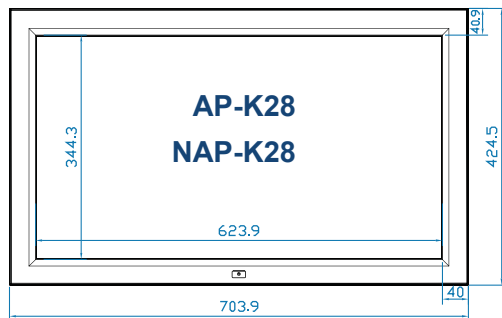

Side View

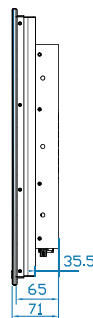

Rear View

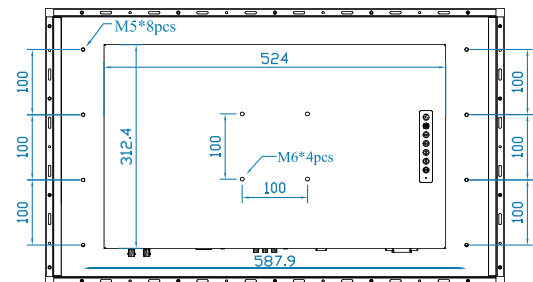

Front View

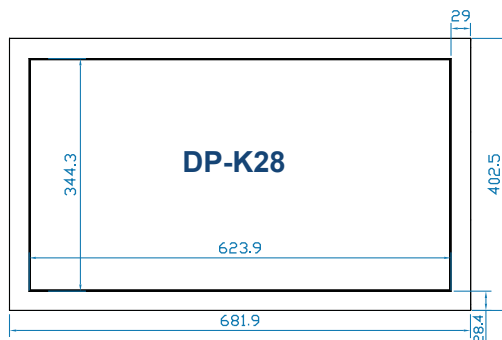

Side View

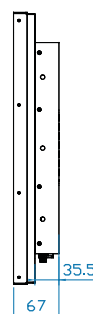

Rear View

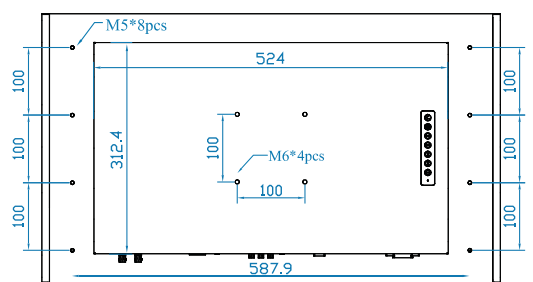

Front View

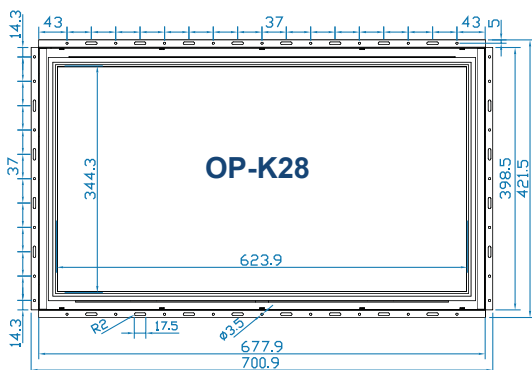

Side View

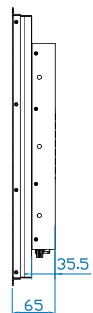

Rear View

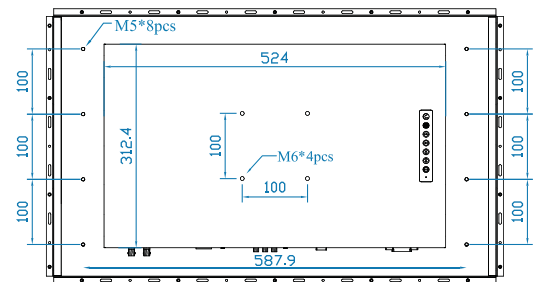

Options — Video Management & Transmission over Network

Embedded HDMI Decoder Module 1080p over IP

- Decodes RTSP, RTMP, UDP, HTTP, HLS protocols
- Supports video resolutions up to 1080p / 60Hz
- Unicast and multicast support
- Operates on standard 1000Mb Ethernet networks
- Built-in Web UI for configuration and control
- Excellent image quality with very low delay

K28 w/ decoder

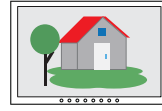

K28 w/ decoder



.....

K28 w/ receiver



K28 w/ receiver

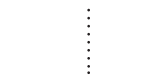

Up to 250 monitors

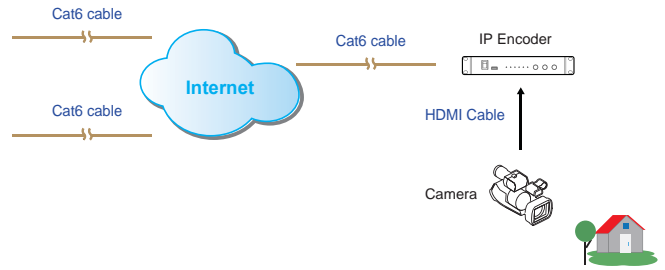

Part no.

Embedded HDMI Decoder Module : **UV-DE100F**

Standalone HDMI Encoder : **UV-EN100F**

Embedded HDMI Receiver Module 1080p

- Extends the HDMI signal over a single Cat5/6 cable
- Supports video resolutions up to 1080p / 60Hz
- One to one just via Cat5/6 cable
- One to multi via network hub and Cat5/6 cable
- 100m maximum Cat5/6 cable distance
- Supports bi-directional IR communication
- High Speed HDMI 1.3 and HDCP 1.1 compliant
- No software or drivers required

Part no.

Embedded HDMI Receiver Module : **UV-R100F**

Standalone HDMI Transmitter : **UV-T100F**

K28 w/ receiver



K28 w/ receiver

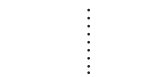

Up to 250 monitors

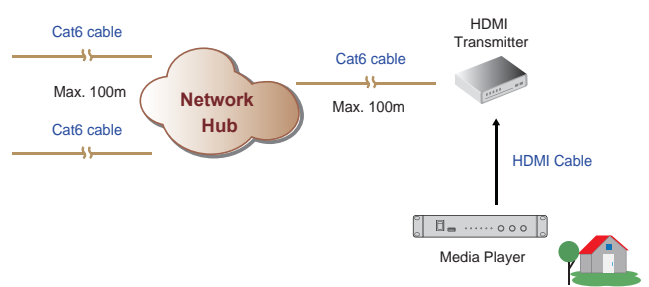

Embedded HDMI Quad Display Module 1080p

- Allows 4 x HDMI inputs to be monitored simultaneously
- Quad split, panel left and full screen monitoring modes
- High speed HDMI 1.3a and HDCP 1.2 compliant
- Supports video resolutions up to 1080p / 60Hz
- Supports Scaler Up and Down function
- Control via local front panel and IR remote

Part no.

Embedded HDMI Quad Display Module : **QD-1080**

Embedded Quad Display Extension Module : **QD-E1080**

K28 w/ Quad Display

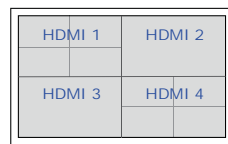

K28 w/ Extension Module

Cat6 cable
Max. 50m

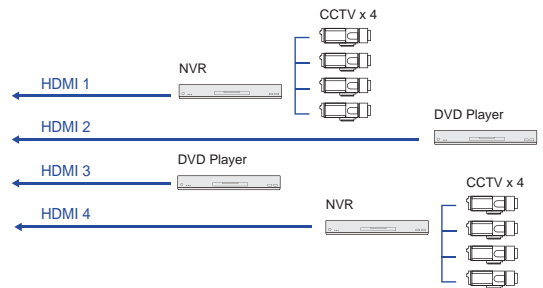

Options — Video Management & Transmission over Network

Embedded Multi Monitor OSD Control Module over serial

- Remote control the monitor OSD via RS-232C serial interface
- Daisy chain up to 64 monitors via Cat5/6 cable
- Individual ID for individual monitor OSD settings
- Power ON or OFF monitor
- Adjust brightness & audio
- Switch video sources

Up to 64 monitors
Up to 1,000m distance

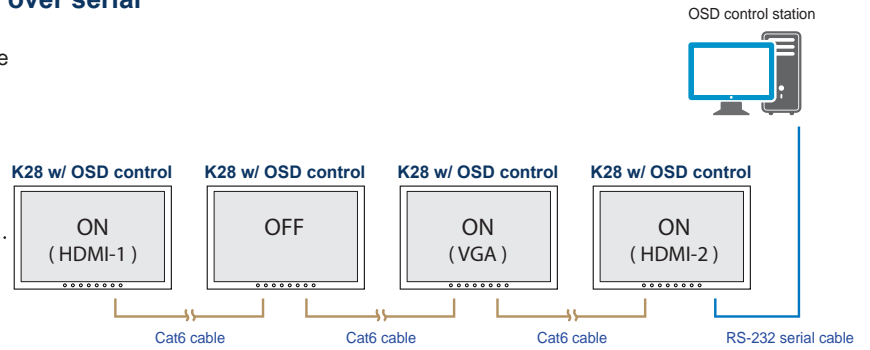

Part no.

Embedded Multi Monitor OSD Control Module : **MCS**

Embedded 3G / HD / SD-SDI Input Module

- Intelligent SDI monitoring with broadcast quality scopes
- Supports multi-rate 3G / HD / SD-SDI format
- Provides input to output loop-through capability
- Auto format sensing & selection

Part no.

Embedded 3G / HD / SD-SDI Input Module : **SDI**

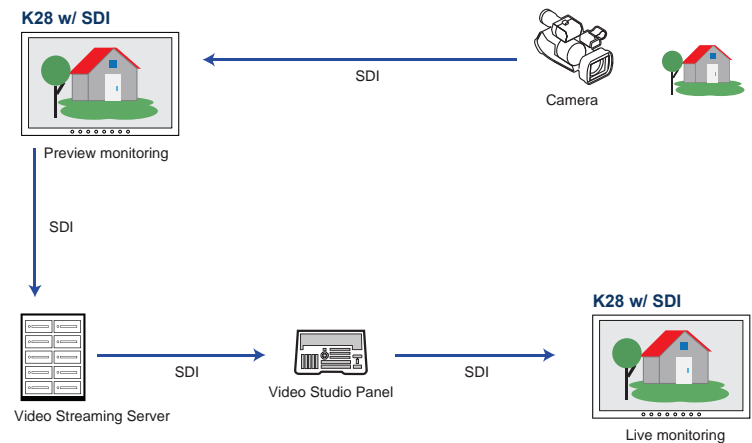

Embedded Portrait Mode Module

- Provides users with a rotation feature (0, 90, 180 & 270 orientation) without frame delay via OSD
- Allows distortion-free display of content in various orientations
- Creates new application opportunities



K28
w/ Portrait mode module

Part no.

Embedded Portrait Mode Module : **AD4.0-P**

Embedded Auto Brightness Dimming Module

- Brightness changes according to its ambient brightness
- Its brightness change causes 10% increase or decrease

Part no.

Embedded Brightness Auto Dimming Module : **DA-01**

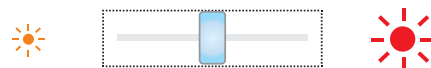

Embedded Manual Brightness Dimming Knob

- Easy-to-use IP54 dimming knob on the front panel
- One click causes 2% brightness increase or decrease
- Brightness adjustment from 0% to 100%

Part no.

Brightness Dimming Knob : **DS-01**

Option — Projected Capacitive 10-point Touch

	TPC-10 Multi-touch
Technology	Projected Capacitive
Touch Point	10 point touch standard (special requirement available)
Input Type	Finger or Capacitive Stylus
Resolution	4096 x 4096
Touch Point Accuracy	± 2 mm
Response Speed	< 5 ms
Activation Force	< 5 g
Surface Hardness	6H
Light Transmission	> 85%
Haze	3%↓
Durability	50 million touches
Top Layer	3 mm Glass
Bottom Layer	1.1 mm Sensor Glass
Thickness	4.3 ± 0.25 mm
Connector	USB
Compatibility	Windows / Linux / Android / Mac

Part no. : K28-TPC10

** Dimension will be changed if multi-touch required

Options — DC Power

		24V	48V	125V
Input rating	Input voltage	24-Volt	48-Volt	110-Volt
	Input range	18 ~ 36V	36 ~ 75V	66 ~ 160V
Input current	No load	50 mA	50 mA	40 mA
	Full load	4880 mA	2442 mA	993 mA
Output rating	Output voltage	24-Volt	24-Volt	24-Volt
	Output current	4.16A	4.16A	4.16A
Efficiency		88%	90%	92%

Part no. : 24VDC
48VDC
125VDC

Product Specifications

LCD Panel	
Panel size (diagonal)	28-inch widescreen TFT color LCD
Native resolution	3840 x 2160
Brightness (cd/m ²)	300
Contrast ratio (typ.)	1000 : 1
Colors	1.07 Billion, 10-bit
Viewing angle (L/R/U/D)	89/89/89/89
Response time (ms)	25
Dot pitch (mm)	0.181
Display area (mm)	620.93H x 341.28V
Surface treatment	Anti-glare
Surface hardness	3H
Backlight type	LED
MTBF (hrs)	30,000

Design	AP-K28	NAP-K28	DP-K28	OP-K28
Protection	6mm front bezel	NEMA 4 / IP65	front cover	open frame
Front panel	Black, RAL 9005			-
Rear casing	Black, RAL 9005			

Mounting	AP-K28 / NAP-K28	DP-K28	OP-K28
VESA mount	100 x 100 mm	100 x 100 mm	100 x 100 mm
Universal mount	-	-	bundled
Overhead tilted wall-mount	option	option	-
Desktop stand	option	option	-
Wall mount	bundled	bundled	-

Video	
Digital :	
Display port	DP 1.2 / HDCP 1.3
HDMI	HDMI 2.0 / HDCP 2.2 HDMI 1.4 / HDCP 1.4

Physical	AP-K28 / NAP-K28	DP-K28	OP-K28
Product (W x D x H) :			
mm	703.9 x 71 x 424.5	681.9 x 67 x 402.5	700.9 x 65 x 421.5
inch	27.7 x 2.8 x 16.7	26.8 x 2.6 x 15.8	27.6 x 2.6 x 16.6
Packing (W x D x H) :			
mm	785 x 175 x 527	785 x 175 x 527	785 x 175 x 527
inch	30.9 x 6.9 x 20.7	30.9 x 6.9 x 20.7	30.9 x 6.9 x 20.7
Net weight	16.8 kg / 37 lb	18.6 kg / 40.9 lb	14.8 kg / 32.6 lb
Gross weight	20.4 kg / 44.9 lb	22.2 kg / 48.8 lb	18.4 kg / 40.5 lb
Chassis color	dark		
Chassis materials	Aluminum		

Audio	
Audio input :	
Connector	3.5mm stereo jack
Impedance / Power level	30kΩ / 750mV
Audio output :	
Connector	3.5mm stereo jack
Resistance / Power level	30kΩ / 2.8V
Speaker :	
Dual stereo speaker	10W x 2

Compliance	
EMC	FCC & CE certified
Safety	CE / LVD certified
Environment	RoHS2 & REACH compliant

*When the audio output is connected, speaker output is OFF

Power	
Input	Auto-sensing 100 to 240VAC, 50 / 60Hz
Consumption :	
Screen on	Max. 52W
Power saving mode	Max. 9W
Power button on	Max. 2W

Applicable Format		
Display port input	PC signal	3840 x 2160 x 60Hz 1920 x 1080 x 60Hz 1600 x 1200 x 60Hz 1360 x 768 x 60Hz 1280 x 1024 x 60 / 75Hz 1280 x 768 x 60Hz 1024 x 768 x 60 / 70 / 75Hz 800 x 600 x 60 / 72 / 75Hz 720 x 400 x 70Hz 640 x 480 x 60 / 72 / 75Hz
	Audio signal	2ch Linear PCM
HDMI input	HDMI 2.0	3840 x 2160 x 60 Hz
	HDMI 2.0 / 1.4	3840 x 2160 x 30 Hz 1920 x 1080 x 50 / 60Hz (1080p) 1920 x 1080 x 25 / 30Hz (1080i) 1280 x 720 x 50 / 60Hz (720p) 720 x 480 x 50 / 60Hz (576p / 480p)
		Audio signal

Environment	
Operating temp.	0 to 55°C degree
Storage temp.	-20 to 60°C degree
Operating humidity	20~90%, non-condensing
Storage humidity	5 ~90%, non-condensing
Operating altitude	16,000 ft
Non-operating altitude	40,000 ft
Shock	10G acceleration (11ms duration)
Vibration	10~300Hz 0.5G RMS random vibration

The Industrial series covers a full range of professional LCD display sizes from 6.5" to 65". Please select from the below the most suitable model for your application.

[Sales Inquiry](#)

isales@rackmountsales.com

[Technical Support](#)

sales@rackmountsales.com

16 : 9

(4K / 1080p)

- K65"
- K55"
- K43"
- K32"
- K28"
- K23"
- K17"
- K15"

16 : 9

(1080p)

- F21"
- F17"
- F15"

16 : 10

- X24" (1920 x 1200)
- X17" (1920 x 1200)
- W19" (1440 x 900)

4 : 3

- 20" (1600 x 1200)
- 19" (1280 x 1024)
- 17" (1280 x 1024)
- 15" (1024 x 768)
- 12" (800 x 600)
- 10" (800 x 600)
- 8" (800 x 600)
- 6" (640 x 480)

Sunlight Readable



16 : 9

(4K / 1080p)

- K65"
- K55"
- K43"
- K32"

16 : 9

(1080p)

- F21"
- F17"

16 : 10

- W19" (1440 x 900)

4 : 3

- 19" (1280 x 1024)
- 17" (1280 x 1024)