

# 1U Short Depth LCD Keyboard Drawer



## LCD Drawer Benefits

- ▶ Short depth design of 480mm (18.9") only
- ▶ Depth will suit a 600mm rack application
- ▶ "One Man" installation slides for easy, quick installation
- ▶ 104 key notepad keyboard with full numerical pad

## Drawer Features & Options

- 1U rackmount drawer with either 15", 17" or 19" LCD
- Combo interface either PS/2 or USB input to the LCD drawer
- Multiple keyboard language selections with either touchpad or trackball
- Slide rails with fixed positions to prevent drawer movement when typing
- Enhanced aesthetics with new molded front panel and two point lock

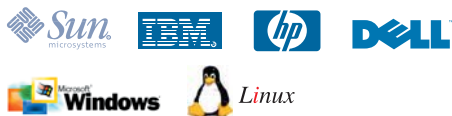

## Options



BNC + S-Video



DVI-D



DC Power



Touch Screen



Audio

### BNC + S-Video

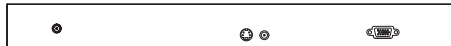

### Touchscreen - USB



### DVI-D



### Touchscreen - Serial



### DC Power



### Audio

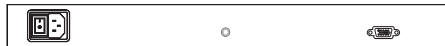

## Diagram

Unit : mm

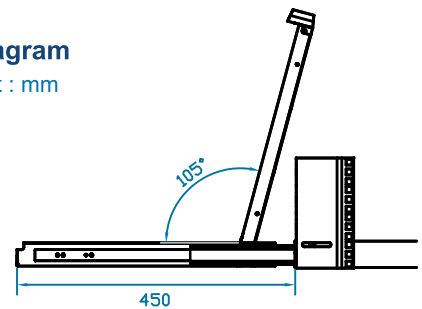

\*\*With DVI-D or DC power option, the depth will be extended from 480mm ( 18.9" ) to 530mm ( 20.9" )

\*\*With touchscreen option, the height will be changed from 1U to 1.5U

## Keyboard Selection

Supporting layouts



### keyboard integrated with touchpad

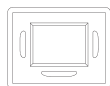
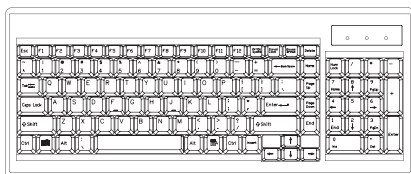

### keyboard integrated with trackball

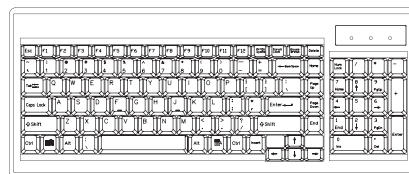

## Monitor Grade A Dimensions

Model	Product Dimension (W x D x H)	Packing Dimension (W x D x H)	Net Weight	Gross Weight
15 Series	442 x 480 x 44 mm 17.4 x 18.9 x 1.73 inch	581 x 705 x 175 mm 22.9 x 27.8 x 6.9 inch	15 kg / 33 lbs	21 kg / 46 lbs
17 Series	442 x 480 x 44 mm 17.4 x 18.9 x 1.73 inch	581 x 705 x 175 mm 22.9 x 27.8 x 6.9 inch	16 kg / 35 lbs	22 kg / 48 lbs
19 Series	442 x 480 x 44 mm 17.4 x 18.9 x 1.73 inch	581 x 705 x 175 mm 22.9 x 27.8 x 6.9 inch	17 kg / 37 lbs	23 kg / 51 lbs

Item	Description					
Form Factor	1U rack mounting on slide-out rails					
LCD Manufacturer				-		
Series	RM Series			SUN Series		
Diagonal Size	15" TFT	17" TFT	19" TFT	17" TFT	19" TFT	
Max. Resolution	1024 x 768	1280 x 1024	1280 x 1024	1152 x 900 (Direct) 1280 x 1024 (Native)	1152 x 900 (Direct) 1280 x 1024 (Native)	
Brightness (cd/m <sup>2</sup> )	250	300	300	300	300	
Color Support	16.2 M	16.7 M	16.7 M	16.7 M	16.7 M	
Contrast Ratio (typ.)	700:1	1000:1	1000:1	1000:1	1000:1	
Viewing Angle (H/V)	150° x 135°	160° x 160°	160° x 160°	160° x 160°	160° x 160°	
Display Area (mm)	304 x 228	338 x 270	376 x 301	338 x 270	376 x 301	
Tr Response Time (ms)	2	1.3	1.3	1.3	1.3	
LCD Panel MTBF (hrs)	50,000	50,000	50,000	50,000	50,000	
VGA Signal Input	Analog RGB, 0.7Vp-p					
Sync. Type	Separate H/V, Composite, SOG					
Resolution	640 x 400, 70 Hz	-				
	720 x 400, 70 Hz					
	640 x 480, 60/ 70/ 72/ 75 Hz					
	800 x 600, 60/ 70/ 72/ 75 Hz					
	1024 x 768, 60/ 70/ 72/ 75 Hz	1024 x 768, 60/ 70/ 75 Hz				
	-	1152 x 864, 60/ 70/ 75 Hz				
	-	1280 x 720, 60/ 70/ 75 Hz				
	-	1280 x 1024, 60/ 70/ 72/ 75 Hz				
	1152 x 900, 66 /76Hz					
Plug & Play DDC	EDID 1.3					
Console Port (Combo)	DB-15 connector for VGA / keyboard / mouse (Combo interface)			DB-15 connector for VGA / keyboard / mouse Support USB servers or Combo KVM switches		
Power Input	Auto-sensing 100 to 240VAC, 50 / 60Hz					
Power Consumption	Max. 48 Watt, Standby 5 Watt					
Compatibility	Multi-platform - Mix PCs, SUNs, IBMs, HPs & DELLs.					
Regulation Approval	FCC, CE					

### Options

KVM Integration	Matrix & combo KVM with IP console and 2-console selection					
Keyboard & mouse	Full size keyboard built-in touch-pad / trackball			SUN-compatible keyboard integrated with 3-button touchpad / trackball		
Graphic Input	DVI-D, BNC & S-Video input			-		
DC Power	DC power input with 12V, 24V, 48V selection					
Touchscreen	Resistive & capacitive			-		

### Environmental

Operation	0° to 50°C Degree					
Storage	-5° to 60 °C Degree					
Relative Humidity	5~90%, non-condensing					
Shock	10G acceleration (11ms duration)					
Vibration	5~500Hz 1G RMS random vibration					