

LCD Drawer & KVM Benefits

- ▶ 2U dual slide rackmount drawer with either 15", 17" or 19" LCD
- ▶ Short depth design of 480mm (18.9") only
- ▶ Depth will suit a 600mm rack application
- ▶ Multi-user Matrix KVM with either 16 or 32 ports in 2U
- ▶ Cost efficient Combo KVM integration
- ▶ Secure remote user access across the world wide web
- ▶ "One Man" installation slides for easy, quick installation



Drawer Features & Options

- Combo interface either PS/2 or USB input to the LCD drawer
- Multiple keyboard language selections with either touchpad or trackball
- Slide rails with fixed positions to prevent drawer movement when typing
- Enhanced aesthetics with new molded front panel and two point lock



Options



BNC + S-Video



DVI-D



DC Power



Touch Screen



Audio

BNC + S-Video



Touchscreen - USB



DVI-D

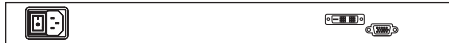

Touchscreen - Serial

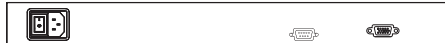

DC Power



Audio

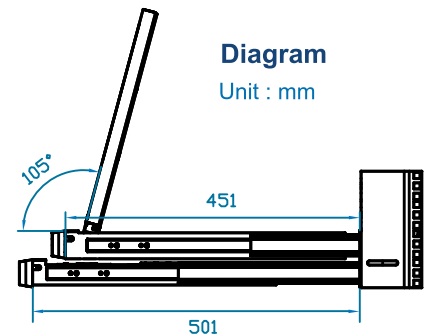

****With DC power option, the depth will be extended from 480mm (18.9") to 530mm (20.9")**

Monitor Grade A 15", 17" or 19" industrial TFT LCD panel

Dimensions

Model	Product Dimension (W x D x H)	Packing Dimension (W x D x H)	Net Weight	Gross Weight
2-15 / 2-17	442 x 480 x 88 mm 17.4 x 18.9 x 3.5 inch	584 x 616 x 216 mm 23 x 24.3 x 8.5 inch	17 kg / 37 lbs	23 kg / 51 lbs
2-19	442 x 480 x 88 mm 17.4 x 18.9 x 3.5 inch	584 x 616 x 216 mm 23 x 24.3 x 8.5 inch	18 kg / 40 lbs	24 kg / 53 lbs

Keyboard Selection

Supporting layouts



keyboard integrated with touchpad

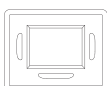
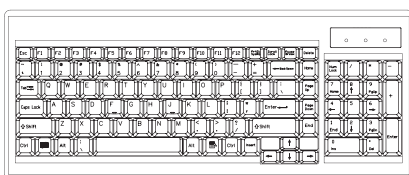

keyboard integrated with trackball

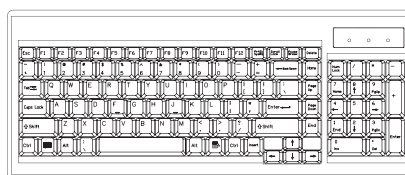

Item	Description				
Form Factor	1U rack mounting on slide-out rails				
LCD Manufacturer				-	
Series	R			"S"	
Diagonal Size	15" TFT	17" TFT	19" TFT	17" TFT	19" TFT
Max. Resolution	1024 x 768	1280 x 1024	1280 x 1024	1152 x 900 (Direct) 1280 x 1024 (Native)	1152 x 900 (Direct) 1280 x 1024 (Native)
Brightness (cd/m ²)	250	300	300	300	300
Color Support	16.2 M	16.7 M	16.7 M	16.7 M	16.7 M
Contrast Ratio (typ.)	700:1	1000:1	1000:1	1000:1	1000:1
Viewing Angle (H/V)	150° x 135°	160° x 160°	150° x 135°	160° x 160°	160° x 160°
Display Area (mm)	304 x 228	338 x 270	376 x 301	338 x 270	376 x 301
Tr Response Time (ms)	2	1.3	1.3	1.3	1.3
LCD Panel MTBF (hrs)	50,000	50,000	50,000	50,000	50,000
VGA Signal Input	Analog RGB, 0.7Vp-p				
Sync. Type	Separate H/V, Composite, SOG				
Resolution	640 x 400, 70 Hz	-			
	720 x 400, 70 Hz				
	640 x 480, 60/ 70/ 72/ 75 Hz				
	800 x 600, 60/ 70/ 72/ 75 Hz				
	1024 x 768, 60/ 70/ 72/ 75 Hz	1024 x 768, 60/ 70/ 75 Hz			
	-	1152 x 864, 60/ 70/ 75 Hz			
	-	1280 x 720, 60/ 70/ 75 Hz			
	-	1280 x 1024, 60/ 70/ 72/ 75 Hz			
	-			1152 x 900, 66 /76Hz	
Plug & Play DDC	EDID 1.3				
Console Port (Combo)	DB-15 connector for VGA / keyboard / mouse (Combo interface)		DB-15 connector for VGA / keyboard / mouse Support USB servers or Combo KVM switches		
Power Input	Auto-sensing 100 to 240VAC, 50 / 60Hz				
Power Consumption	Max. 48 Watt, Standby 5 Watt				
Compatibility	Multi-platform - Mix PCs, SUNs, IBMs, HPs & DELLs.				
Regulation Approval	FCC, CE				

Options

KVM Integration	Matrix & combo KVM with IP console and 2-console selection				
Keyboard & mouse	Full size keyboard built-in touch-pad / trackball			SUN-compatible keyboard integrated with 3-button touchpad / trackball	
Graphic Input	DVI-D, BNC & S-Video input			-	
DC Power	DC power input with 12V, 24V, 48V selection				
Touchscreen	Resistive & capacitive			-	

Environmental

Operation	0° to 50°C Degree				
Storage	-5° to 60°C Degree				
Relative Humidity	5~90%, non-condensing				
Shock	10G acceleration (11ms duration)				
Vibration	5~500Hz 1G RMS random vibration				