

User Manual **17" Ultra High Resolution LCD 1920 x 1200**



RMD-151-X17 1U LCD Drawer

Options :

- SDI
- HDMI / Audio
- Touchscreen / DC power

Contents

< Part. 1 > RMD-151-X17

1.1	Package Content	P.1
1.2	Structure Diagram & Dimension	P.1 - 2
1.3	Installation	P.3

< Part. 2 > Specifications / OSD

2.1	Product Specifications	P.4 - 5
2.2	On-screen Display Operation (OSD)	P.6 - 7

< Part. 3 > Options

3.1	3G / HD / SD- SDI Broadcast-grade input	P.8
3.2	HDMI & Audio	P.9
3.3	X17" Touchscreen : Resistive, Capacitive	P.10
3.4	48V, 24V or 12VDC power	P.11

Before Installation

- It is very important to mount the equipment in a suitable cabinet or on a stable surface.
- Make sure the place has a good ventilation, is out of direct sunlight, away from sources of excessive dust, dirt, heat, water, moisture and vibration.

Unpacking

The equipment comes with the standard parts shown in package content. Check and make sure they are included and in good condition. If anything is missing, or damaged, contact the supplier immediately.

How To Clean Your LCD Monitor



Caution :

- To avoid the risk of electric shock, make sure your hands are dry before unplugging your monitor from or plugging your monitor into an electrical outlet.
- When you clean your monitor, do not press down on the LCD screen. Pressing down on the screen can scratch or damage your display. Pressure damage is not covered under warranty.
- Use only cleansers made specifically for cleaning monitors and monitor screens. Cleansers not made to clean monitors and monitor screens can scratch the LCD display or strip off the finish.
- Do not spray any kind of liquid directly onto the screen or case of your monitor. Spraying liquids directly onto the screen or case can cause damage which is not covered under warranty.
- Do not use paper towels or abrasive pads to clean your monitor. Using an abrasive pad or any wood based paper product such as paper towels can scratch your LCD screen.

Cleaning Your Monitor

To clean your LCD safely, please follow these steps :

- ① Disconnect the power cord.
- ② Gently wipe the surface using a clean, dry microfiber cloth. Use as little pressure as possible.

Cleaning Tough Marks and Smudges

To remove tough marks and smudges, please follow these steps :

- ① Disconnect the power cord.
- ② Spray a small amount of non-abrasive cleanser on a microfiber cloth.



Caution : Do not spray or apply any liquids directly onto the monitor. Always apply the solution to your microfiber cloth first, not directly on the parts you are cleaning.

- ③ Gently wipe the surface. Use as little pressure as possible.
- ④ Wait until your monitor is completely dry before plugging it in and powering it up.

< Part 1 >

< 1.1 > Package Content

RMD-151-X17



RMD-151-X17 X 1

6ft VGA cable X 1

Power cord X 1

M6 screw, cage nut & cup washer X 8



The above package content is only for the pure model (VGA and DVI-D only). It varies with options such as SDI, HDMI, audio, touchscreen & DC power.

< 1.2 > Structure Diagram

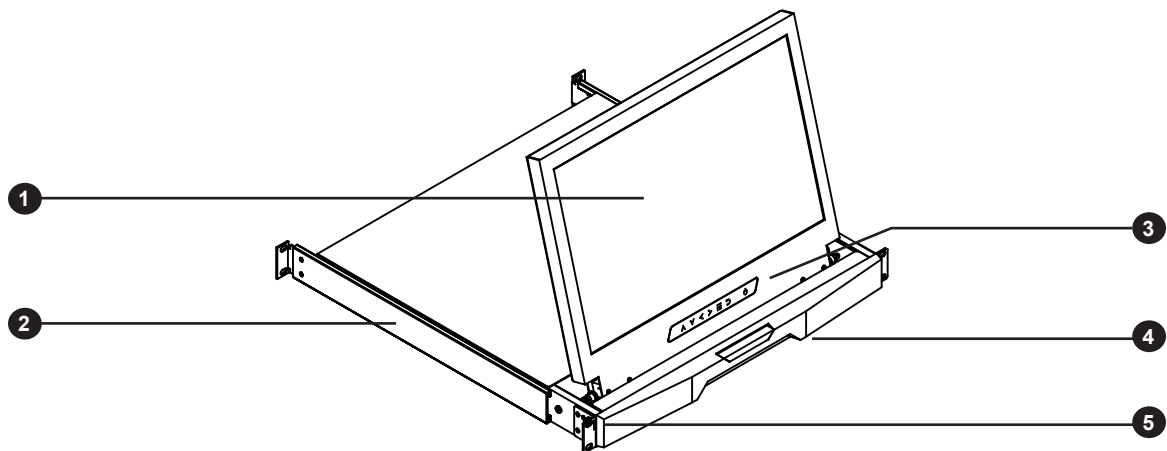

① LCD panel

② Installation Slide

③ LCD OSD membrane

④ Carry handle to release the 2-pt lock

⑤ 2-point lock



< 1.2 > Dimension

Front View

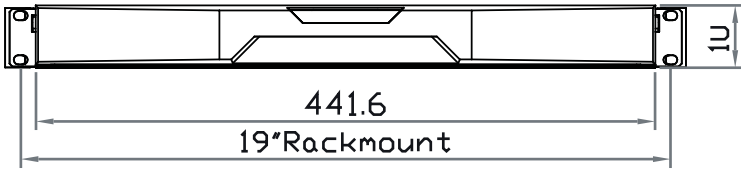

Side View



UNIT : mm
1mm = 0.03937 inch

Top View

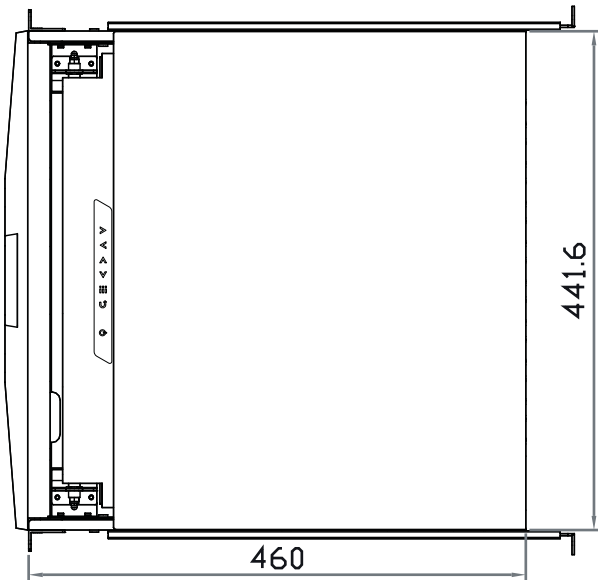

Model	Product Dimension (W x D x H)	Packing Dimension (W x D x H)	Net Weight	Gross Weight
RMD-151-X17	441.6 x 460 x 44 mm 17.4 x 18.1 x 1.73"	590 x 687 x 120 mm 23.2 x 27 x 4.7"	11 kg 24 lb	15 kg 33 lb

! The weight is only for the pure models. It varies with accessories & options such as SDI, HDMI, audio, touchscreen & DC power.

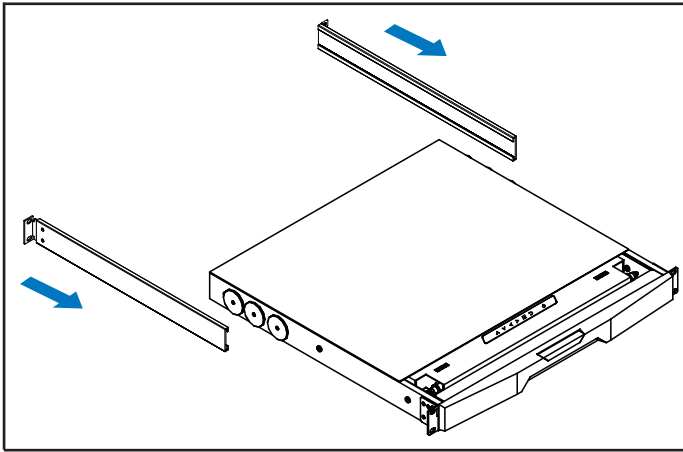

Step 1

- Insert the left and right rear mounting bracket into the display drawer.

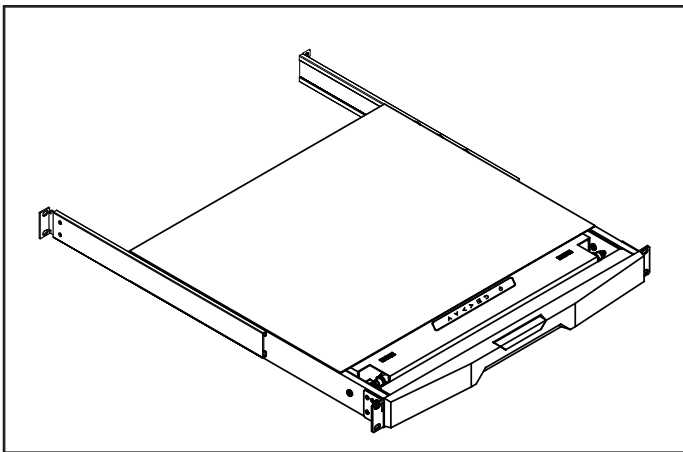

Step 2

- Measure the depth of the front and rear mounting rails.
- Align each rear mounting bracket to a suitable length.

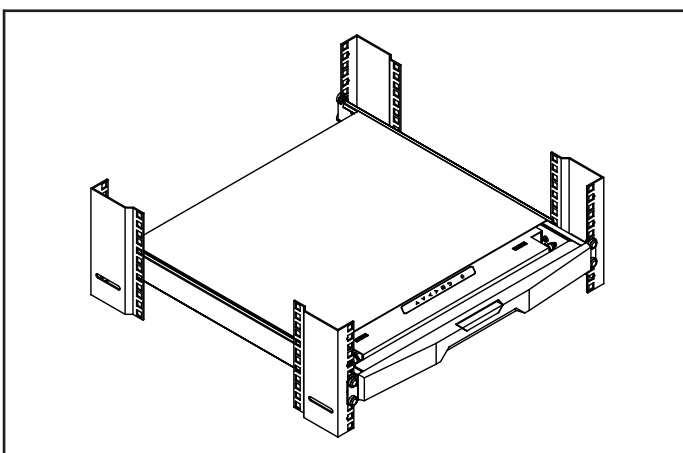

Step 3

Complete the installation

- Fix the display drawer into the rack.

 **M6 screw, cage nut & cup washer x 8 are provided.**

< Part 2 > Specifications / OSD

< 2.1 > Product Specifications

LCD Panel	Panel Size (diagonal)	16.2-inch Widescreen TFT color LCD
	Display pixel (dots x lines)	1920 x 1200
	Brightness (typ.)	300
	Contrast Ratio (typ.)	800:1
	Color	16.7 M, 8-bit
	Viewing Angle (L/R/U/D)	89/89/89/89
	Response Time (ms)	30
	Dot pitch (mm)	0.191
	Display Area (mm)	343.80H x 214.90V
	Surface treatment	Anti-glare, Hard-coating
	Surface hardness	3H
	Backlight Type	LED
MTBF (hrs)	20,000	

Video Connectivity	Digital	HDMI	HDMI 1.4, CEA-861-E
		DVI	DVI-D, TMDS single link
	Analog	VGA	Analog 0.7Vp-p
	Plug & Play	DVI / VGA	VESA EDID structure 1.3
	Synchronization	VGA	Separate, Composite & SOG

Audio Connectivity	Audio Output	Connector	3.5mm stereo jack
		Resistance / Power level	30kΩ / 2.8V
	Speaker	Dual Stereo Speaker	2W x 2

*When the audio output is connected, speaker output is OFF

Power	Power Supply	Range	Auto-sensing 100 to 240VAC, 50 / 60Hz
	Power Consumption	Screen ON	Max. 34W
		Power saving mode	Max. 4W
		Power button OFF	Max. 1W

Regulatory	Safety	FCC & CE certified
	Environmental	RoHS2 & REACH compliant





Environmental Conditions	Operating	Temperature	0 to 55°C degree
		Humidity	20~90%, non-condensing
		Altitude	16,000 ft
	Storage / Non-operating	Temperature	-20 to 60°C degree
		Humidity	5~90%, non-condensing
		Altitude	40,000 ft
		Shock	10G acceleration (11ms duration)
		Vibration	5~500Hz 1G RMS random

Physical Specification	Product (W x D x H)	441.6 x 480 x 44 mm 17.4 x 18.9 x 1.73 inch
	Packing (W x D x H)	588 x 758 x 120 mm 23.1 x 29.8 x 4.7 inch
	Net Weight	11 kg / 24.2 lb
	Gross Weight	15 kg / 33 lb

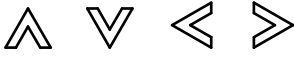

Applicable Format	DVI-D / VGA Input	PC Signal	1920 x 1200 x 60Hz	
			1360 x 768 x 60Hz	
			1280 x 1024 x 60 / 75Hz	
			1280 x 960 x 60Hz	
			1280 x 768 x 60 / 75Hz	
			1152 x 864 x 75Hz	
			1024 x 768 x 60 / 70 / 75Hz	
			848 x 480 x 60Hz	
			800 x 600 x 60 / 72 / 75Hz	
			720 x 400 x 70Hz	
			640 x 480 x 60 / 72 / 75Hz	
			640 x 400 x 70Hz	
			640 x 350 x 70Hz	
	HDMI Input	PC Signal	Same as VGA	
			Video Signal	1080p : 60Hz
				720p : 50 / 60Hz
				480p : 60Hz
		576p : 50Hz		
		Audio Signal	2ch Linear PCM (32 / 44.1 / 48 KHz)	

< 2.2 > On-screen Display Operation (OSD)



Membrane Switch	Function
	Turn the monitor on or off
	Display the OSD menu Act as an Enter key to select screen setting options
	Scroll through menu options and adjust the displayed control
	Exit the OSD screen Go back to the previous on-screen sub-menu or main menu

All LED touch buttons in **WHITE** light

- ① When the monitor is connected to power and first turn on, all LED touch buttons will light on in 6 - 8 seconds. The time is necessarily required for the monitor to load the software for its operation. During this time period, no picture is displayed on the screen, the monitor will not respond to all touch buttons or remote control.
- ② When the monitor is turned off, locate the touch buttons in low ambient light conditions by pressing any touch buttons (except the **Power** ) to light up all LED touch buttons for 2 seconds.
- ③ All the LED touch buttons will automatically turn off after 30 seconds of idle status (except the **Power** ).
- ④ The LED of **Power**  touch button will flash continuously when there is no signal input.

① Picture

Picture mode :	Standard / Vivid / Soft / User mode to choose
Brightness :	Adjust background black level of the screen image
Contrast :	Adjust the difference between the image background (black level) and the foreground (white level)
Hue:	Adjust the screen hue value
Saturation :	Adjust the saturation of the image color
Picture size :	Adjust the image size
Color temp :	Standard / Cool / Warm / User to choose
Noise reduce :	Reduce the noise of the image
Sharpness :	Adjust the image from weak to sharp

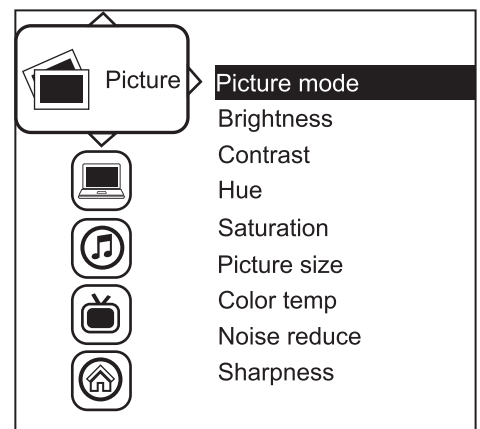

< 2.2 > On-screen Display Operation (OSD)

RMD-X17

② PC

- Auto adjust : Automatically adjust sizes, centers and fine tunes the video signal to eliminate waviness and distortion.
- Clock : Adjust the clock value
- Phase : Adjust the phase value
- H. Position : Align the screen image left or right
- V. Position : Align the screen image up or down

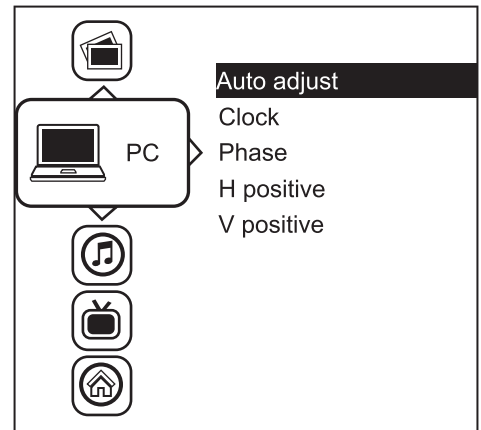

③ Audio

- Audio mode : Movie / Voice / Normal / Music mode to choose
- Volume : Adjust the volume of sound
- Bass : Set the value of bass sound
- Treble : Set the value of treble sound
- Balance : Set the balance value of treble and bass sound
- Analog TV audio : Set the value of analog TV audio sound
- Mute : Turn off the surrounding sound

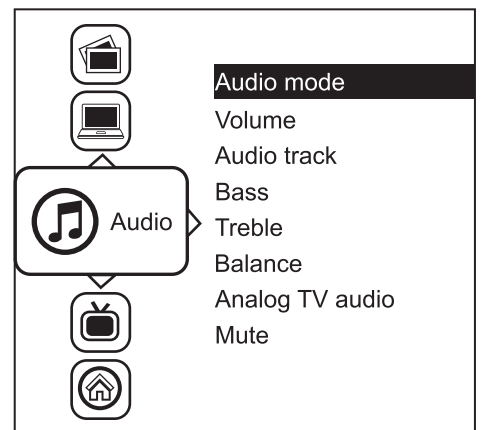

④ MISC

- Language : Select the language in which the OSD menu is displayed - English
- Sleep timer : Set the off time
- PIP mode : Adjust picture in picture setting
- PIP position : Enter into PIP position
- PIP source : Enter into the Sub source and sound source
- System reset : Return the adjustment back to factory setting
- Information : Select for Help

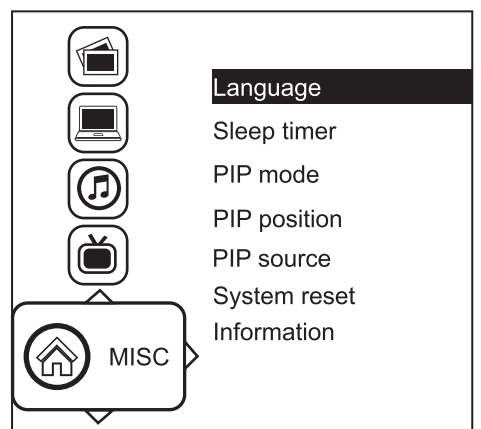

< Part 3 >

< 3.1 > Options : 3G / HD / SD-SDI input



Austin Hughes' SDI input is an ideal solution for the broadcast-grade video and high resolution CCTV market.

Designed for use with CyberView Full HD 1080p and ultra high resolution 1920 x 1200 LCD displays, Austin Hughes provides a SDI input module without using additional space or power and it comes standard with a 2-year warranty.

SDI



INPUT	3G-SDI IN	BNC x 1 / 0.8Vp-p (75 ohm)
	3G-SDI OUT	BNC x 1 / Active through, equalized & relocked

Standard Compliance	Video	SMPTE 425M / 274M / 296M / 125M ITU-R BT.656
	Audio	SMPTE 299M / 272M-C

Compatible Video Format	3G-SDI	1080p @60 / 50Hz, 4:2:2
		1080p @30 / 25 / 24Hz, 4:4:4
		1080i @60 / 50Hz, 4:4:4
		720p @60 / 50Hz, 4:4:4
	HD-SDI	1080p @30 / 25 / 24Hz, 4:2:2
		1080i @60 / 50Hz, 4:2:2
		720p @60 / 50Hz, 4:2:2
SD-SDI	480i @60Hz, 4:2:2	
ITU-R BT.656	576i @50Hz, 4:2:2	

Compatible Audio Format	3G-SDI	48kHz, 16 / 20 / 24 bit, 2 CH, Synchronized Video
	HD-SDI	48kHz, 16 / 20 / 24 bit, 2 CH, Synchronized Video
	SD-SDI	48kHz, 16 / 20 / 24 bit, 2 CH, Synchronized / Asynchronized Video

Max. Transmission Distance 75 ohm coaxial cable	3G-SDI	150m at 2.97Gb/s
	HD-SDI	250m at 1.485Gb/s
	SD-SDI	480m at 270Mb/s

< 3.2 > Options :

RMD-151-X17

- HDMI
- Audio



HDMI : HDMI 1.1, CEA-861-D

Audio : 3.5mm audio jacks for audio in & out, and 2W + 2W speakers

< 3.3 > Options : Touchscreen & driver



X17" USB Touchscreen Specification

Model	TRB e-Resistive	TCB e-Capacitive
Technology	5-Wire Resistive	Capacitive
Touch Point	Single	Single
Method	Stylus or Finger	Finger
Activation Force	≤ 50g / Stylus=R0.8	≤ 50g
Durability	10 million touches	300 million touches
Response Time	15 ms	20 ms
Optical Transmittance	80% ± 3%	92% ±2%
Surface Hardness	3H	9H
Haze	8% ± 3%	7%
Glass	2.2 ±0.2 mm	2.8 mm ±10%
Connector	USB Type A	
Compatibility	Windows 7 / XP / Vista, Linux	

- USB touchscreen package includes 1 x 6ft USB cable, quick reference guideline and CD disc
- For detailed information, please refer to the attached CD disc
- As the touchscreen unit is not made of toughened glass, please handle it carefully

USB Touchscreen



TRB & TCB Driver

Please follow the below steps to setup the touch screen:-

- Step 1.** Run the bundled CD disc
- Step 2.** Double click the Setup.exe
- Step 3.** Follow the installation instruction to finish the setup
- Step 4.** After installation, run the TouchKit program & the "4 point calibration"



Please do the initial calibration after the first setup

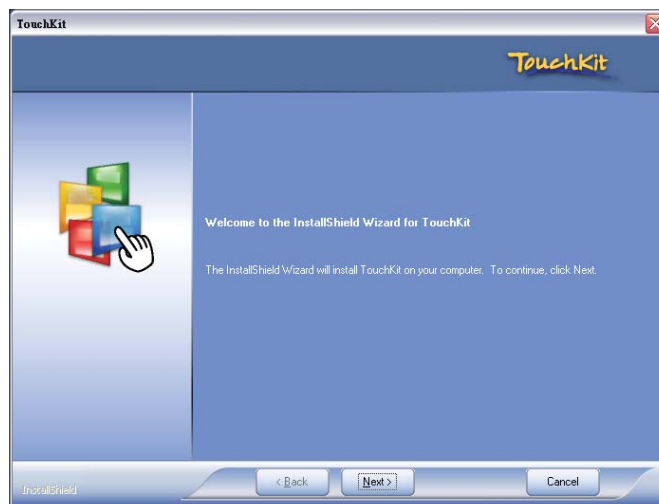

Model	12V	24V	48V
Input rating			
Input voltage:	12-Volt	24-Volt	48-Volt
Input range:	9 ~ 18V	18 ~ 36V	36 ~ 75V
Input current			
- No load	50 mA	50 mA	50 mA
- Full load	4950 mA	2450 mA	1220 mA
Output rating			
Output voltage:	12-Volt	12-Volt	12-Volt
Output current:	4.16A	4.16A	4.16A
Efficiency	84%	85%	85%

DC power



Option excludes 1 x power cord and 1 x AC power adapter

