

User Manual 15" 4K 3480 x 2160 LCD



LCD-AP-K15

Aluminum front bezel

LCD-NAP-K15

Front NEMA4 / IP65

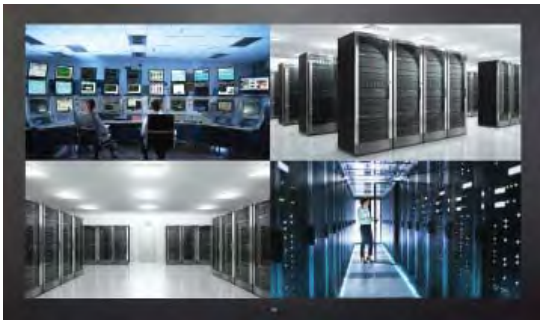

LCD-DP-K15

Aluminum front cover



LCD-OP-K15

Universal open frame

Legal Information

First English printing, September 2018

Information in this document has been carefully checked for accuracy; however, no guarantee is given to the correctness of the contents. The information in this document is subject to change without notice. We are not liable for any injury or loss that results from the use of this equipment.

Safety Instructions

Please read all of these instructions carefully before you use the device. Save this manual for future reference.

- Unplug equipment before cleaning. Don't use liquid or spray detergent; use a moist cloth.
- Keep equipment away from excessive humidity and heat. Preferably, keep it in an air-conditioned environment with temperatures not exceeding 40° Celsius (104° Fahrenheit).
- When installing, place the equipment on a sturdy, level surface to prevent it from accidentally falling and causing damage to other equipment or injury to persons nearby.
- When the equipment is in an open position, do not cover, block or in any way obstruct the gap between it and the power supply. Proper air convection is necessary to keep it from overheating.
- Arrange the equipment's power cord in such a way that others won't trip or fall over it.
- If you are using a power cord that didn't ship with the equipment, ensure that it is rated for the voltage and current labeled on the equipment's electrical ratings label. The voltage rating on the cord should be higher than the one listed on the equipment's ratings label.
- Observe all precautions and warnings attached to the equipment.
- If you don't intend on using the equipment for a long time, disconnect it from the power outlet to prevent being damaged by transient over-voltage.
- Keep all liquids away from the equipment to minimize the risk of accidental spillage. Liquid spilled on to the power supply or on other hardware may cause damage, fire or electrical shock.
- Only qualified service personnel should open the chassis. Opening it yourself could damage the equipment and invalidate its warranty.
- If any part of the equipment becomes damaged or stops functioning, have it checked by qualified service personnel.

What the warranty does not cover

- Any product, on which the serial number has been defaced, modified or removed.
- Damage, deterioration or malfunction resulting from:
 - Accident, misuse, neglect, fire, water, lightning, or other acts of nature, unauthorized product modification, or failure to follow instructions supplied with the product.
 - Repair or attempted repair by anyone not authorized by us.
 - Any damage of the product due to shipment.
 - Removal or installation of the product.
 - Causes external to the product, such as electric power fluctuation or failure.
 - Use of supplies or parts not meeting our specifications.
 - Normal wear and tear.
 - Any other causes which does not relate to a product defect.
- Removal, installation, and set-up service charges.

Regulatory Notices Federal Communications Commission (FCC)

This equipment has been tested and found to comply with the limits for a Class B digital device, pursuant to Part 15 of the FCC rules. These limits are designed to provide reasonable protection against harmful interference in a residential installation.

Any changes or modifications made to this equipment may void the user's authority to operate this equipment. This equipment generates, uses, and can radiate radio frequency energy and, if not installed and used in accordance with the instructions, may cause harmful interference to radio communications.

However, there is no guarantee that interference will not occur in a particular installation. If this equipment does cause harmful interference to radio or television reception, which can be determined by turning the equipment off and on, the user is encouraged to try to correct the interference by one or more of the following measures:

- Re-position or relocate the receiving antenna.
- Increase the separation between the equipment and receiver.
- Connect the equipment into an outlet on a circuit different from that to which the receiver is connected.

Contents

< Part. 1 > LCD-AP-K15 / NAP-K15

| | | |
|-----|----------------------------------|---------|
| 1.1 | Package Content | P.1 |
| 1.2 | Structure Diagram & Dimension | P.2 - 3 |
| 1.3 | Mounting Hardware & Installation | P.4 - 5 |

< Part. 2 > LCD-DP-K15

| | | |
|-----|----------------------------------|---------|
| 2.1 | Package Content | P.6 |
| 2.2 | Structure Diagram & Dimension | P.7 - 8 |
| 2.3 | Mounting Hardware & Installation | P.9 |

< Part. 3 > LCD-OP-K15

| | | |
|-----|----------------------------------|-----------|
| 3.1 | Package Content | P.10 |
| 3.2 | Structure Diagram & Dimension | P.11 - 12 |
| 3.3 | Mounting Hardware & Installation | P.13 |

< Part. 4 > Specifications / OSD

| | | |
|-----|---|-----------|
| 4.1 | Product Specifications | P.14 - 15 |
| 4.2 | On-screen Display Operation (OSD) | P.16 - 18 |
| 4.3 | Picture In Picture (PIP) / Picture By Picture (PBP) | P.19 - 20 |

< Part. 5 > Options

| | | |
|-----|--|-----------|
| 5.1 | Option Table | P.21 |
| 5.2 | Remote Controller (RC-2) | P.22 |
| 5.3 | 3G / HD / SD- SDI Broadcast-grade input | P.23 |
| 5.4 | MCS Multi-display control solution | P.24 |
| 5.5 | Touchscreen & driver | P.25 - 26 |
| 5.6 | DC Power | P.26 |
| 5.7 | MIL-type or lockable connector | P.27 |

Before Installation

- It is very important to mount the equipment in a suitable cabinet or on a stable surface.
- Make sure the place has a good ventilation, is out of direct sunlight, away from sources of excessive dust, dirt, heat, water, moisture and vibration.

Unpacking

The equipment comes with the standard parts shown in package content. Check and make sure they are included and in good condition. If anything is missing, or damaged, contact the supplier immediately.

How To Clean Your LCD Monitor



Caution :

- To avoid the risk of electric shock, make sure your hands are dry before unplugging your monitor from or plugging your monitor into an electrical outlet.
- When you clean your monitor, do not press down on the LCD screen. Pressing down on the screen can scratch or damage your display. Pressure damage is not covered under warranty.
- Use only cleansers made specifically for cleaning monitors and monitor screens. Cleansers not made to clean monitors and monitor screens can scratch the LCD display or strip off the finish.
- Do not spray any kind of liquid directly onto the screen or case of your monitor. Spraying liquids directly onto the screen or case can cause damage which is not covered under warranty.
- Do not use paper towels or abrasive pads to clean your monitor. Using an abrasive pad or any wood based paper product such as paper towels can scratch your LCD screen.

Cleaning Your Monitor

To clean your LCD safely, please follow these steps :

- ① Disconnect the power cord.
- ② Gently wipe the surface using a clean, dry microfiber cloth. Use as little pressure as possible.

Cleaning Tough Marks and Smudges

To remove tough marks and smudges, please follow these steps :

- ① Disconnect the power cord.
- ② Spray a small amount of non-abrasive cleanser on a microfiber cloth.



Caution : Do not spray or apply any liquids directly onto the monitor. Always apply the solution to your microfiber cloth first, not directly on the parts you are cleaning.

- ③ Gently wipe the surface. Use as little pressure as possible.
- ④ Wait until your monitor is completely dry before plugging it in and powering it up.

LCD-AP-K15 / NAP-K15



15" 4K LCD Display X 1

6ft DP cable X 1

Power adapter X 1

Power cord X 1

Mounting hardware X 1 pack

- Mounting bracket x 2 pcs

- M4* 6mm screw x 4 pcs

- M4* 50mm screw x 4 pcs

Basic I/O

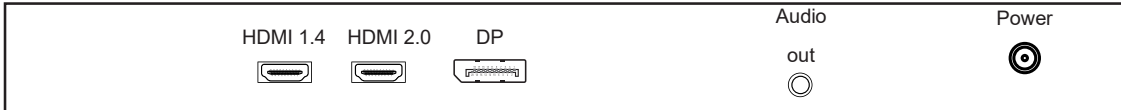

< 1.2 > Structure Diagram - LCD-AP / NAP-K15

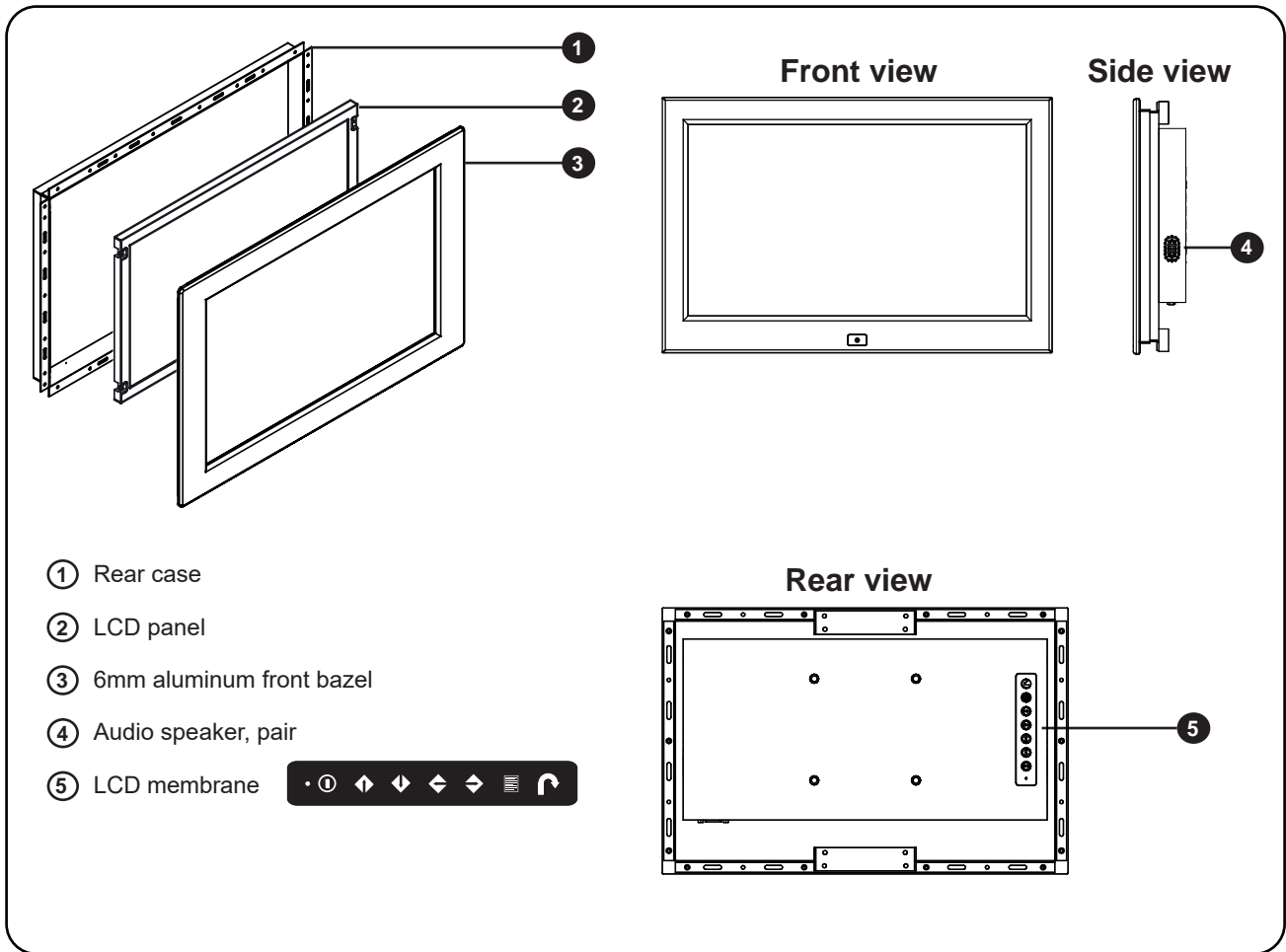

| Model | Product Dimension (W x D x H) | Packing Dimension (W x D x H) | Net Weight | Gross Weight |
|-------------|---|--|--------------------|--------------------|
| LCD-AP-K15 | 399 x 53.6 x 261.6 mm 15.7 x 2.1 x 10.3 inch | 615 x 113 x 523 mm 24.2 x 4.4 x 20.6 inch | 4.7 kg 10.3 lbs | 7.3 kg 16.1 lbs |
| LCD-NAP-K15 | 399 x 53.6 x 261.6 mm 15.7 x 2.1 x 10.3 inch | 615 x 113 x 523 mm 24.2 x 4.4 x 20.6 inch | 4.7 kg 10.3 lbs | 7.3 kg 16.1 lbs |

< 1.2 > Dimension - AP / NAP-K15

15" 4K LCD Display

Front View

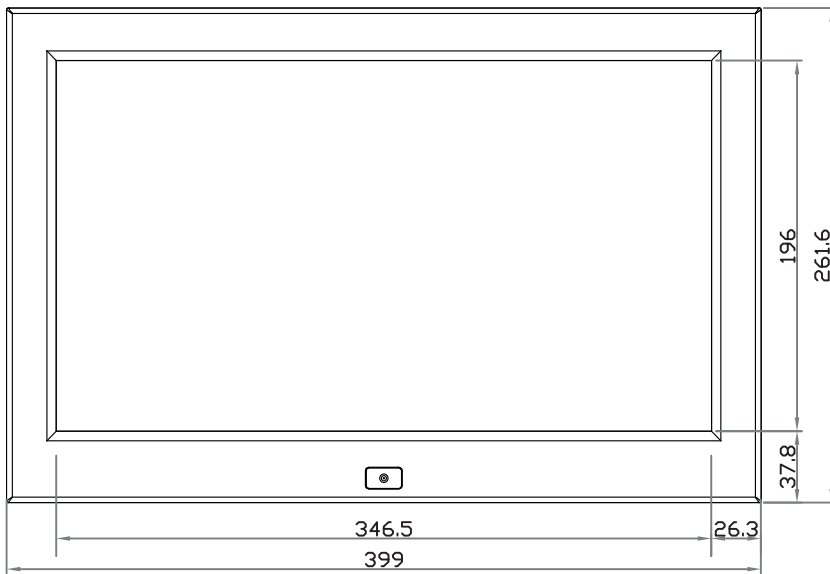

Side View

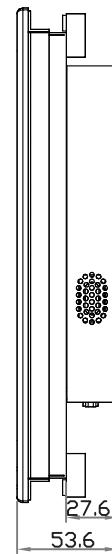

Rear View

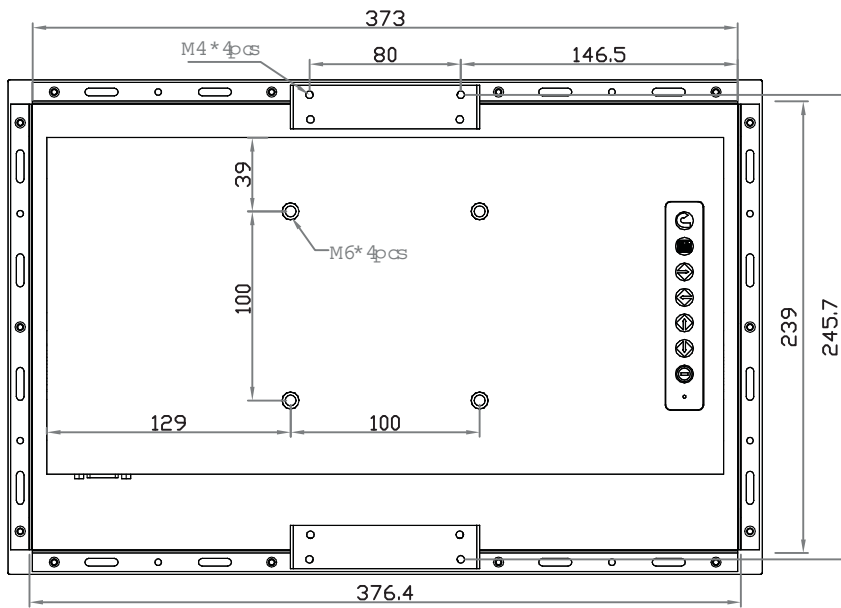

UNIT : mm
1mm = 0.03937 inch

Bottom View

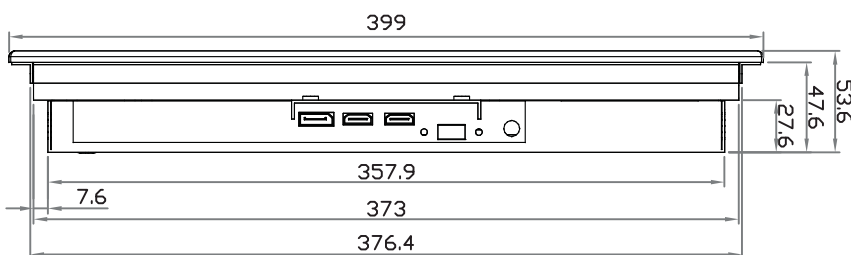

< 1.3 > Panel Mount Installation - LCD-AP / NAP-K15

- 1 Mounting bracket
x 2 pcs

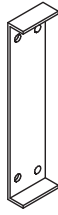

- 2 M4*6mm screw
x 4 pcs



- 3 M4*50mm screw
x 4 pcs

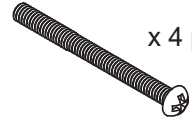

Hardware set part no. UV-BK#2

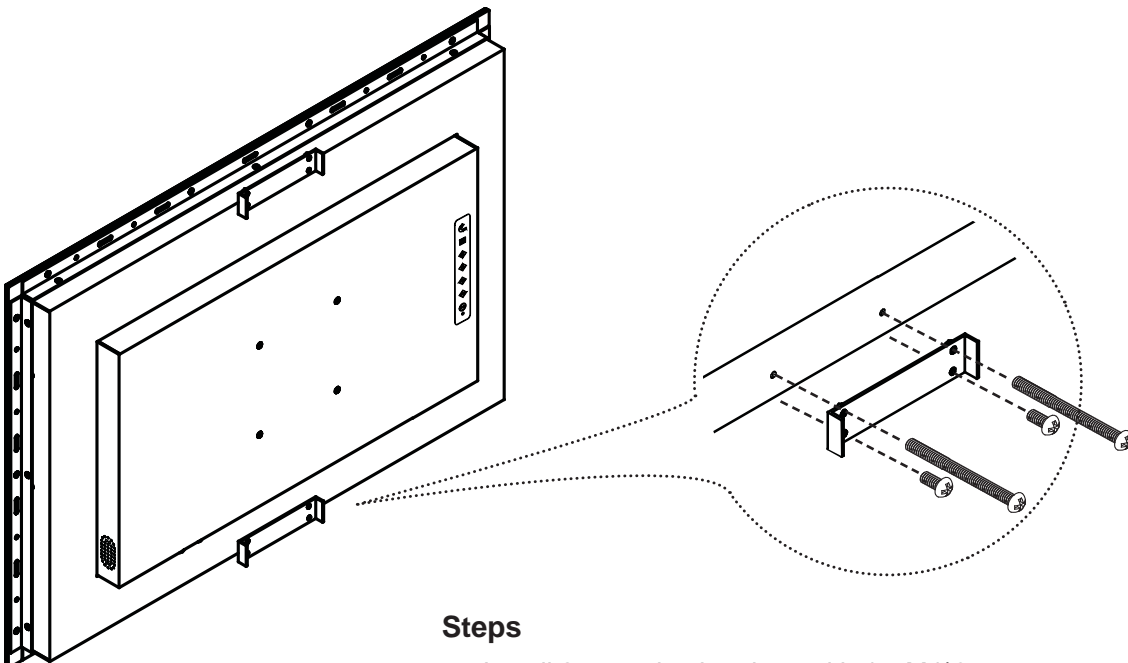

Steps

- Install 2 mounting brackets with 4 x M4*6mm screws
- Adjust the LCD panel with 4 x M4*50mm screws and fix it on the surface.

< 1.3 > VESA mount Installation - LCD-AP / NAP-K15 15" 4K LCD Display

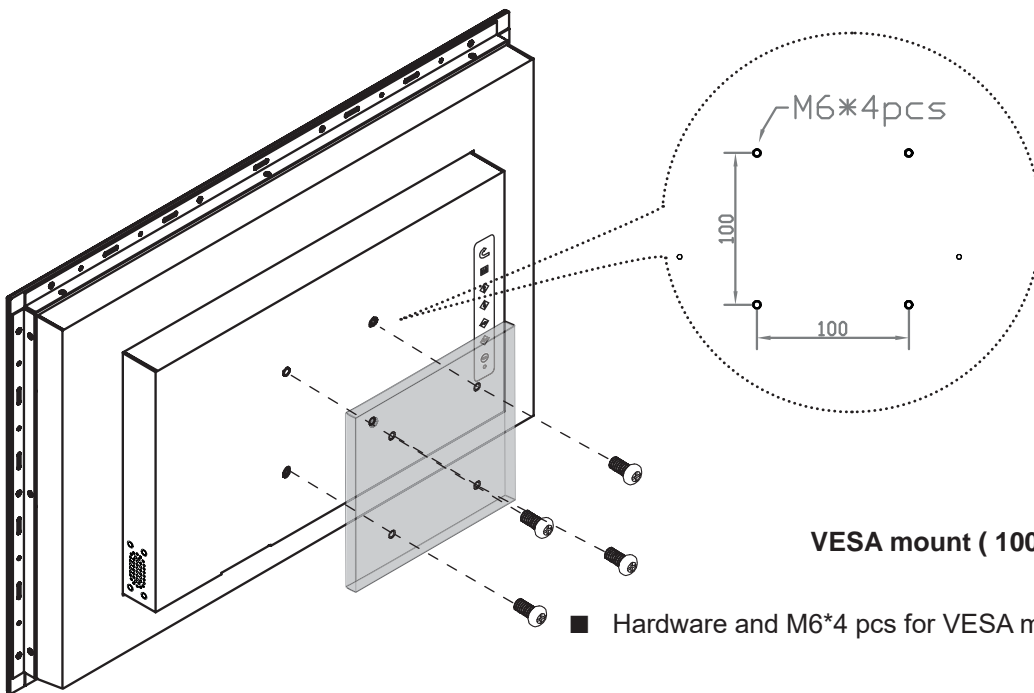

< Part 2 >

< 2.1 > Package Content - LCD-DP-K15

LCD-DP-K15



- 15" 4K LCD Display X 1
- 6ft DP cable X 1
- Power adapter X 1
- Power cord X 1

Basic I/O

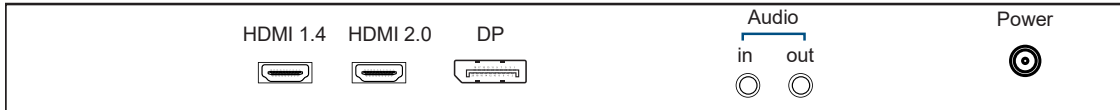

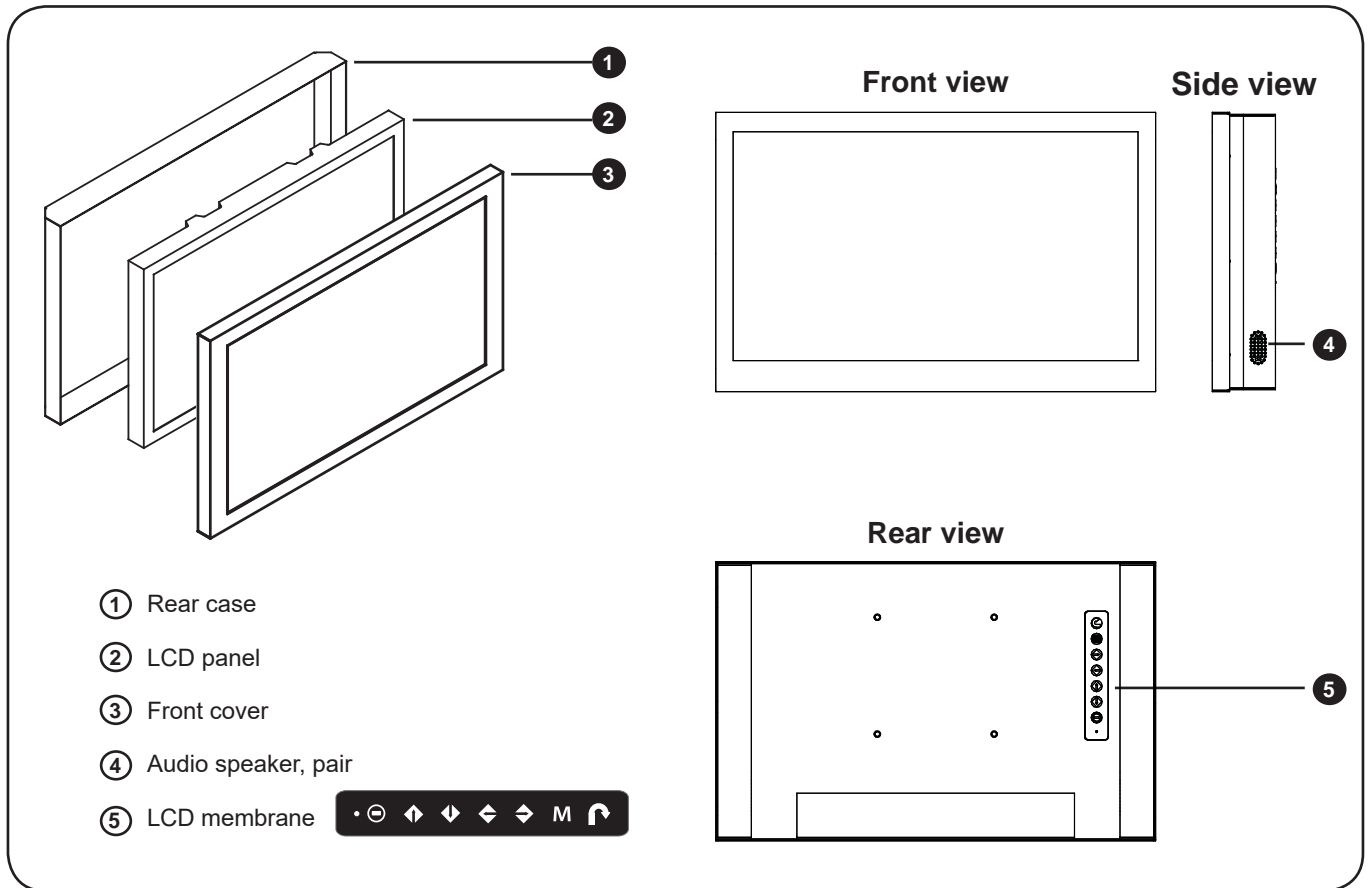

| Model | Product Dimension (W x D x H) | Packing Dimension (W x D x H) | Net Weight | Gross Weight |
|--------|--|--|-----------------|--------------------|
| DP-K15 | 376.4 x 54.4 x 239 mm 14.8 x 2.1 x 9.4 inch | 615 x 113 x 523 mm 24.2 x 4.4 x 20.6 inch | 4.1 kg 9 lbs | 6.7 kg 14.7 lbs |

< 2.2 > Dimension - LCD-DP-K15

Front View

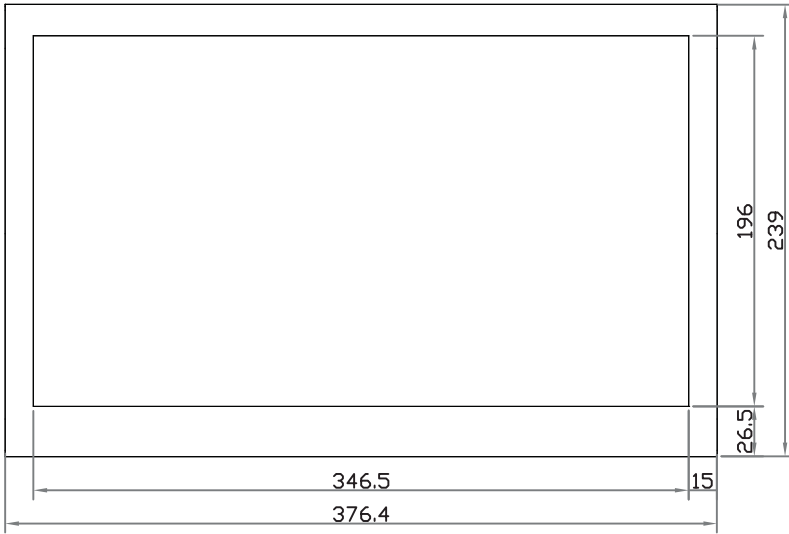

Side View

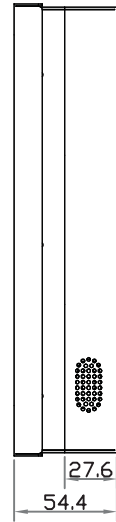

Rear View

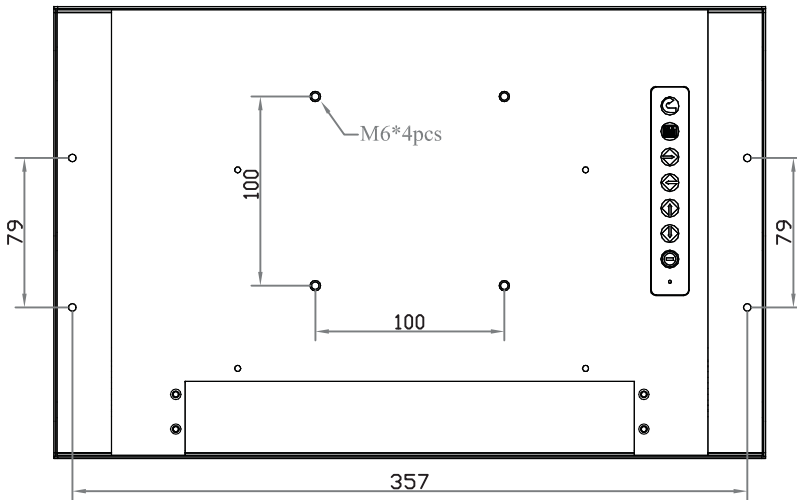

UNIT : mm
1mm = 0.03937 inch

Bottom View

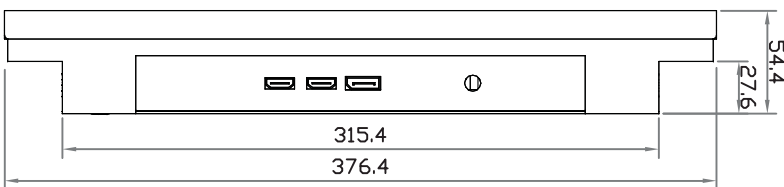

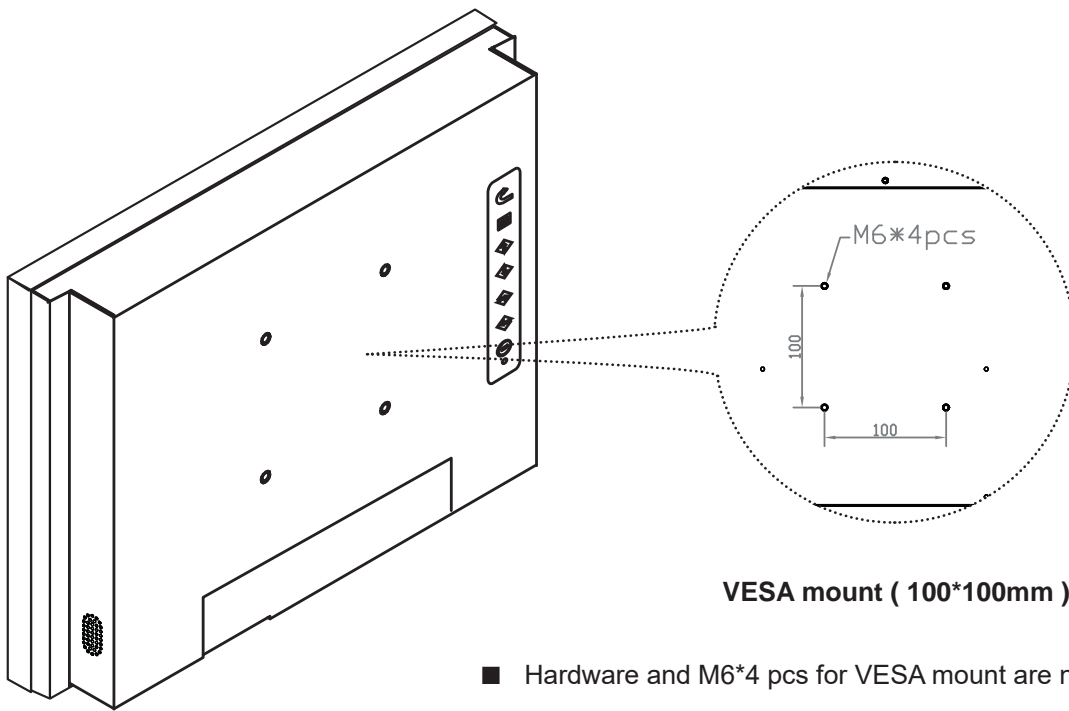

< Part 3 >

< 3.1 > Package Content - LCD-OP-K15

OP-K15



- 15" 4K LCD Display X 1
- 6ft DP cable X 1
- Power adapter X 1
- Power cord X 1

Basic I/O

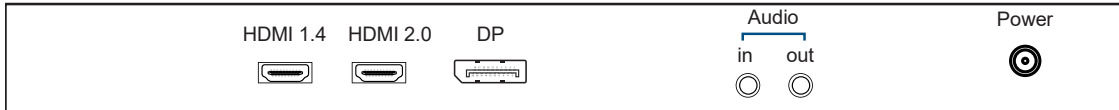

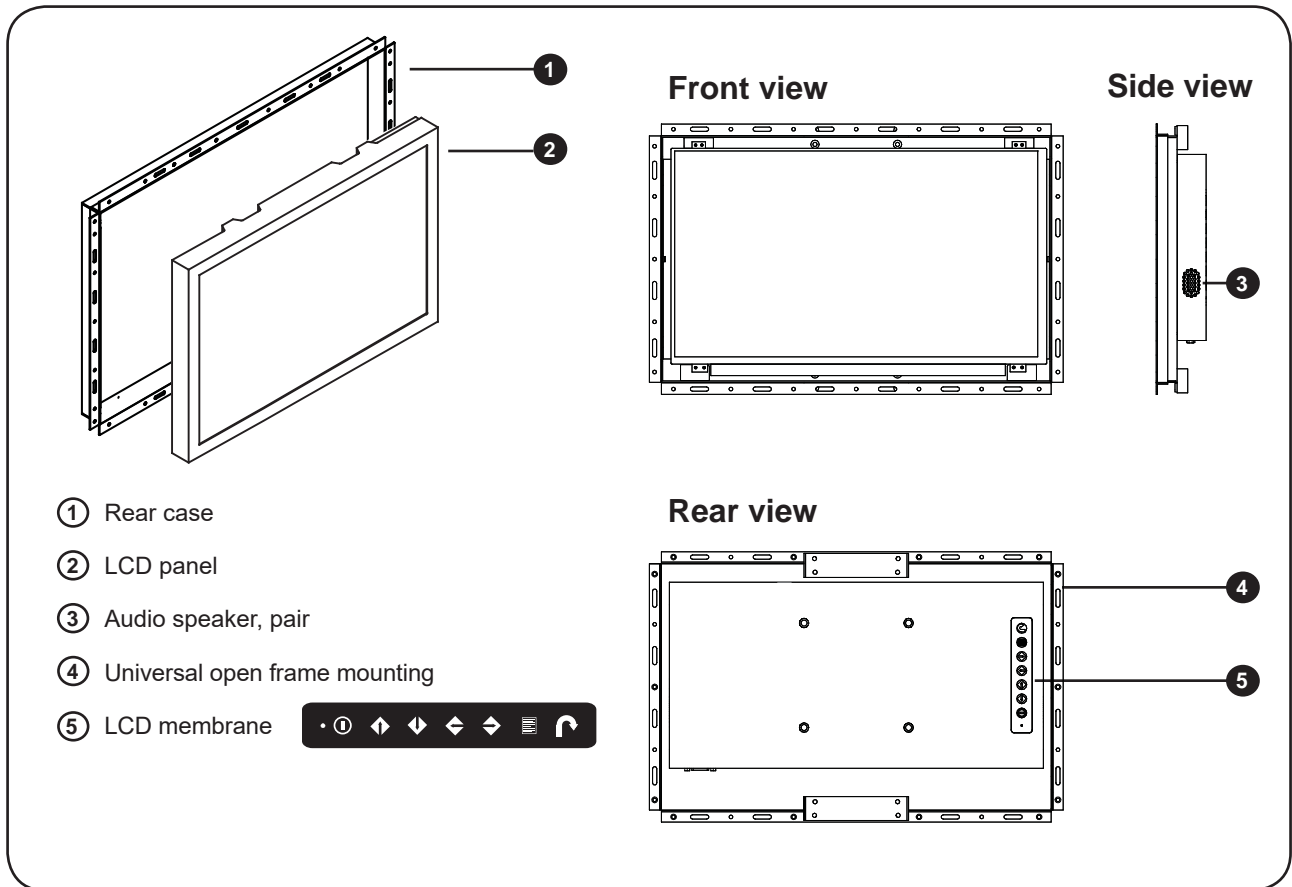

| Model | Product Dimension (W x D x H) | Packing Dimension (W x D x H) | Net Weight | Gross Weight |
|------------|---|--|-------------------|--------------------|
| LCD-OP-K15 | 396 x 47.6 x 258.6 mm 15.9 x 1.9 x 10.2 inch | 615 x 113 x 523 mm 24.2 x 4.4 x 20.6 inch | 3.5 kg 7.7 lbs | 6.1 kg 13.4 lbs |

< 3.2 > Dimension - LCD-OP-K15

Front View

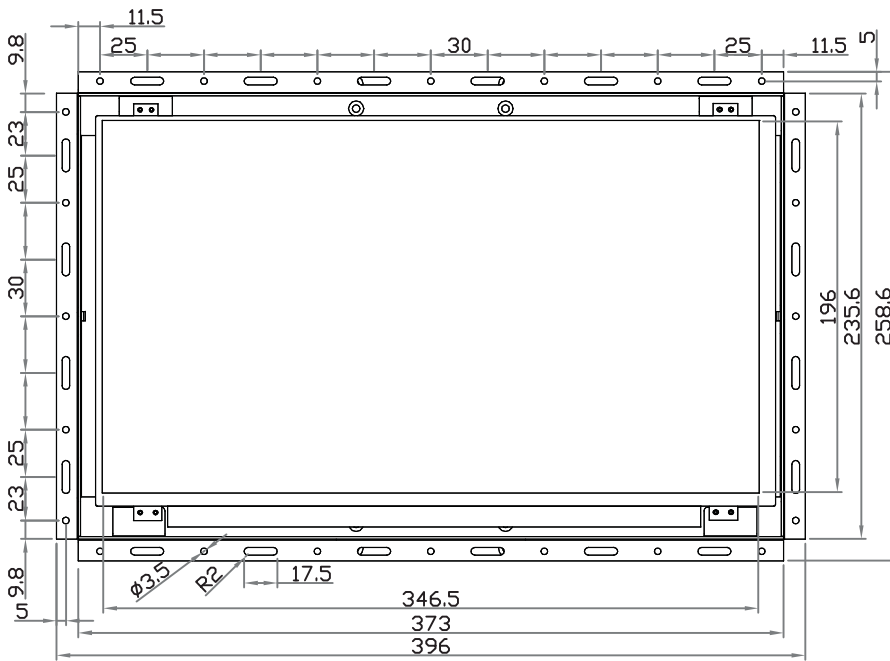

Side View

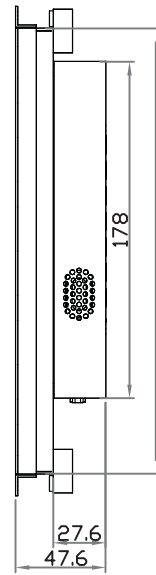

Rear View

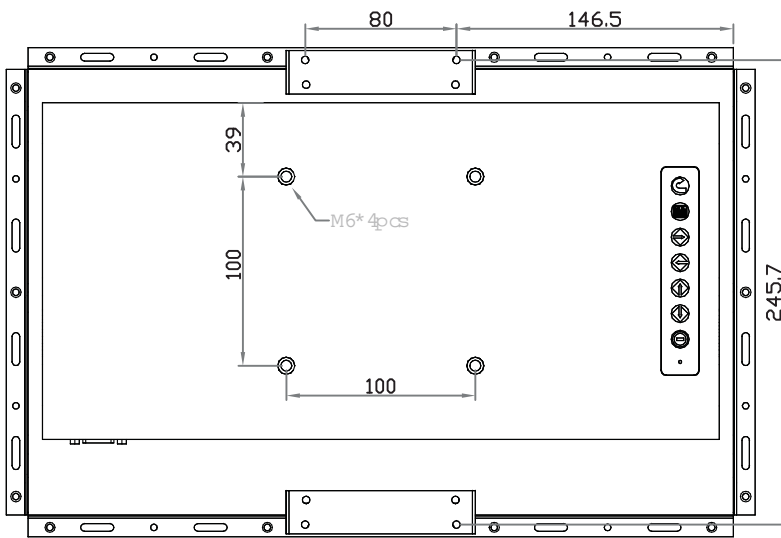

UNIT : mm
1mm = 0.03937 inch

Bottom View

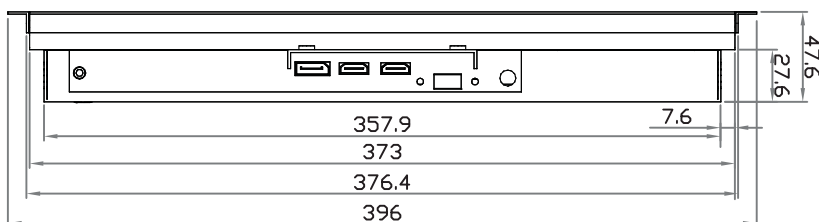

(I) Universal mount

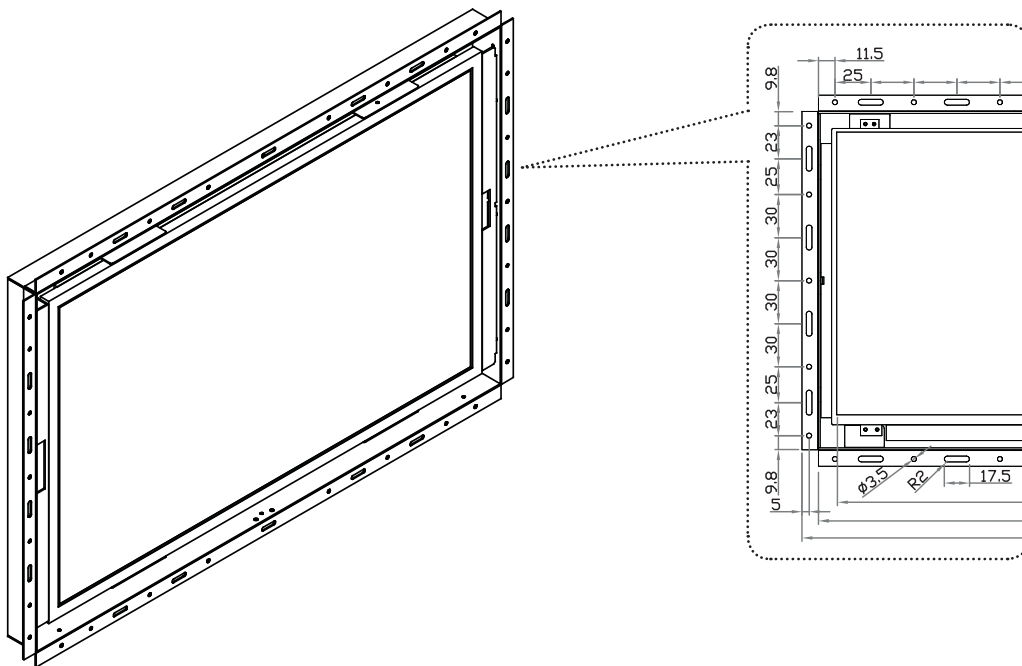

(II) VESA mount (100*100mm)

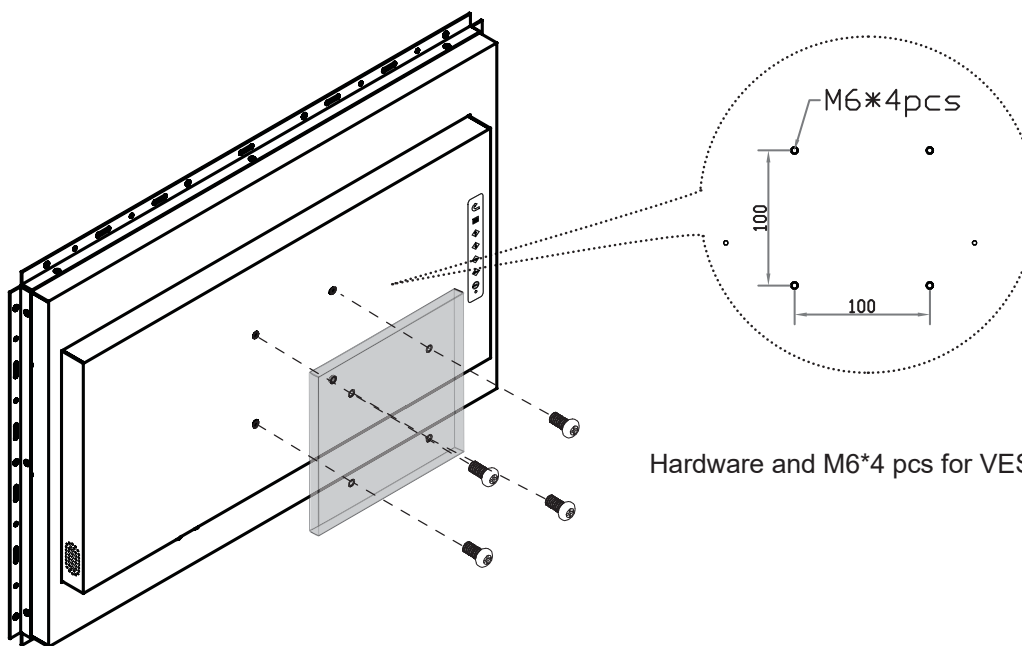

Hardware and M6*4 pcs for VESA mounting are not provided

< Part 4 >

< 4.1 > Product Specifications

| Mechanical Design | | AP-K15 | NAP-K15 | DP-K15 | OP-K15 |
|-------------------|----------------|-----------------|----------------|-------------|-----------------|
| | Protection | 6mm front cover | NEMA 4 / IP 65 | front cover | open frame |
| | Front Panel | Black, RAL 9005 | | | - |
| | Rear Casing | Black, RAL 9005 | | | |
| | VESA Mounting | 100 x 100mm | | | |
| | Other Mounting | Panel mount | Panel mount | - | Universal mount |

| LCD Panel | Panel Size (diagonal) | 15.6-inch Widescreen TFT color LCD |
|-----------|--------------------------------|------------------------------------|
| | Display pixel (dots x lines) | 3840 x 2160 |
| | Brightness (typ.) | 300 |
| | Contrast Ratio (typ.) | 800:1 |
| | Color | 16.7 M, 8-bit |
| | Viewing Angle (L/R/U/D) | 89/89/89/89 |
| | Response Time (ms) | 30 |
| | Dot pitch (mm) | 0.0897 |
| | Display Area (mm) | 344.448H x 193.752V |
| | Surface treatment | Anti-glare |
| | Surface hardness | 3H |
| | Backlight Type | LED |
| | MTBF (hrs) | 20,000 |

| Video | Digital | Display port | DP 1.2 / HDCP 1.3 |
|-------|---------|--------------|---------------------|
| | | HDMI | HDMI 2.0 / HDCP 2.2 |
| | | | HDMI 1.4 / HDCP 1.4 |

| Audio | Audio Output | Connector | 3.5mm stereo jack |
|-------|--------------|--------------------------|-------------------|
| | | Resistance / Power level | 30kΩ / 2.8V |
| | Speaker | Dual Stereo Speaker | 2W x 2 |

*When the audio output is connected, speaker output is OFF

| | | | |
|--------------|-------------------|---------------------------------------|----------|
| Power Supply | Range | Auto-sensing 100 to 240VAC, 50 / 60Hz | |
| | Power Consumption | Screen ON | Max. 24W |
| | | Power saving mode | Max. 9W |
| | | Power button OFF | Max. 2W |

| Compliance | EMC | FCC & CE certified |
|------------|-------------|-------------------------|
| | Safety | CE / LVD certified |
| | Environment | RoHS2 & REACH compliant |

< 4.1 > Product Specifications

15" 4K LCD Display

| | | | |
|---------------------------------|-------------------------|-------------|------------------------------------|
| Environmental Conditions | Operating | Temperature | 0 to 55°C degree |
| | | Humidity | 20~90%, non-condensing |
| | | Altitude | 16,000 ft |
| | Storage / Non-operating | Temperature | -20 to 60°C degree |
| | | Humidity | 5~90%, non-condensing |
| | | Altitude | 40,000 ft |
| | | Shock | 10G acceleration (11ms duration) |
| | | Vibration | 10~300Hz 0.5G RMS random vibration |

| Physical Specification | | LCD-AP/NAP-K15 | LCD-DP-K15 | LCD-OP-K15 |
|-------------------------------|-----------------------|------------------------|------------------------|------------------------|
| | Product (W x D x H) | | 399 x 53.6 x 261.6 mm | 376.4 x 54.4 x 239 mm |
| | | 15.7 x 2.1 x 10.3 inch | 14.8 x 2.1 x 9.4 inch | 15.9 x 1.9 x 10.2 inch |
| Packing (W x D x H) | | 615 x 113 x 523 mm | 615 x 113 x 523 mm | 615 x 113 x 523 mm |
| | | 24.2 x 4.4 x 20.6 inch | 24.2 x 4.4 x 20.6 inch | 24.2 x 4.4 x 20.6 inch |
| Net Weight | | 4.7 kg / 10.3 lb | 4.1 kg / 9 lb | 3.5 kg / 7.7 lb |
| Gross Weight | | 7.3 kg / 16.1 lb | 6.7 kg / 14.7 lb | 6.1 kg / 13.4 lb |





| Applicable Format | Display Port Input | PC Signal | 3840 x 2160 x 60Hz |
|--------------------------|--------------------|----------------|---------------------------------------|
| | | | 1920 x 1080 x 60Hz |
| | | | 1600 x 1200 x 60Hz |
| | | | 1360 x 768 x 60Hz |
| | | | 1280 x 1024 x 60 / 75Hz |
| | | | 1280 x 768 x 60Hz |
| | | | 1024 x 768 x 60 / 70 / 75Hz |
| | | | 800 x 600 x 60 / 72 / 75Hz |
| | | | 720 x 400 x 70Hz |
| | | | 640 x 480 x 60 / 72 / 75Hz |
| | | Audio Signal | 2ch Linear PCM |
| HDMI Input | HDMI 2.0 | | 3840 x 2160 x 60Hz |
| | | | 3840 x 2160 x 30Hz |
| | HDMI 2.0 / 1.4 | | 1920 x 1080 x 50 / 60Hz (1080p) |
| | | | 1920 x 1080 x 25 / 30Hz (1080i) |
| | | | 1280 x 720 x 50 / 60Hz (720p) |
| | | | 720 x 480 x 50 / 60Hz (576p / 480p) |
| | Audio Signal | 2ch Linear PCM | |

* In some circumstances, if the user connects the LCD to PC via HDMI port for video and audio signals, the LCD may display incorrectly on a full screen. If so, please adjust the display card setting on display size to fix the issue.

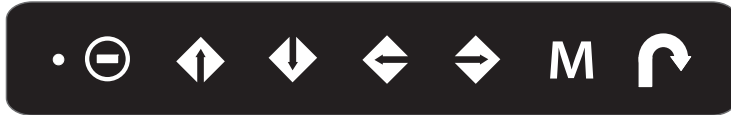
< 4.2 > On-screen Display Operation (OSD)

- Power light
- Green = On
- Orange = Power saving



| Membrane Switch | Function |
|---|---|
|  | Power on / off LCD |
|  | Display the OSD menu |
|  | Scrolls through menu options and adjusts the displayed control (To auto adjustment by pressing the button  for 5 seconds) |
|  | Exit the OSD screen Toggle analog, digital & video connection (DVI-D and video options only) |

< 4.2 > On-screen Display Operation (OSD)

15" 4K LCD Display

① Picture

Brightness : Adjust the screen brightness

Contrast : Adjust the difference between the image background (black level) and the foreground (white level)

Black level : Adjust background black level of the screen

Eco : Screen in power saving mode

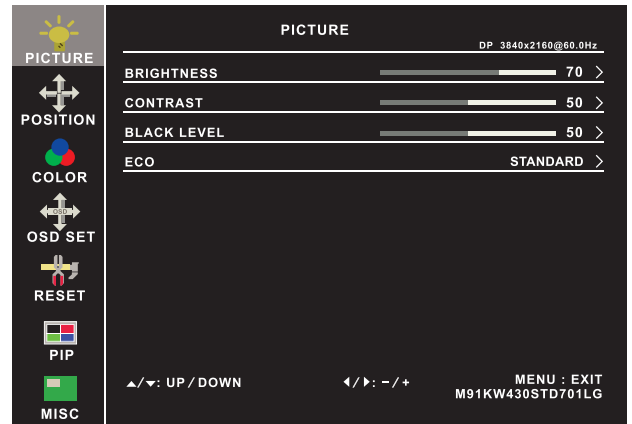

② Position

Picture size : Adjust the image size
- Full Screen / 4:3 / 5:4 / Pixel to Pixel

DP version : Select the DP version

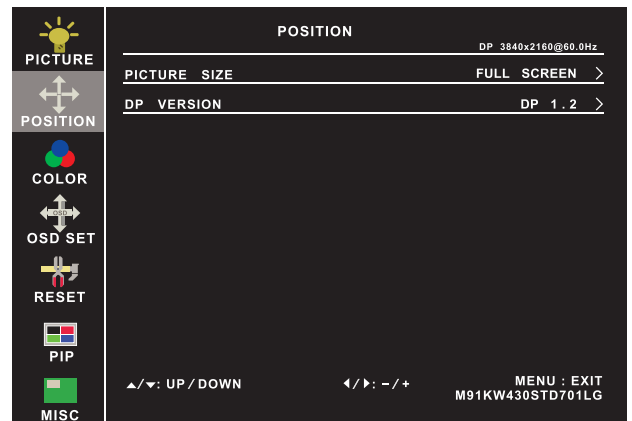

③ Color

Color temperature : User / Warm / Cool / 5400k mode and Red / Green / Blue color balance

Sharpness : Adjust the image from weak to sharp

Hue : Adjust the screen hue value

Saturation : Adjust the saturation of the image color

Dynamic

luminous control : Control the dynamic brightness

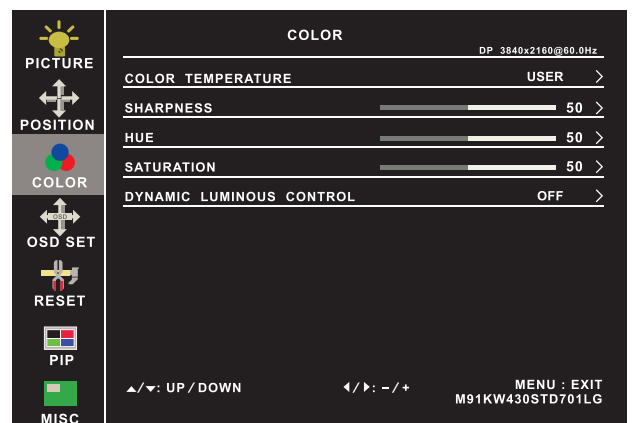

④ OSD Set

Language : Select the language in which the OSD menu is displayed - English

OSD H-Position : Align the screen image left or right

OSD V-Position : Align the screen image up or down

OSD time out : Adjust the screen timeout

OSD transparency : Adjust the screen transparency

OSD size : Adjust the screen size - Normal / Small

OSD rotation : Rotate the screen - 90° / 180° / 270°

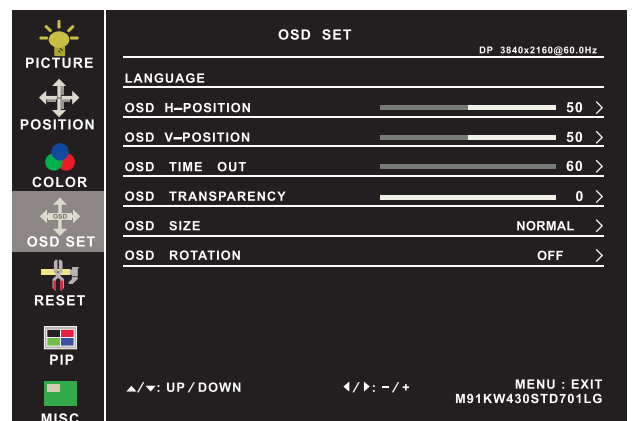

< 4.2 > On-screen Display Operation (OSD)

15" 4K LCD Display

⑤ Reset

Reset : Return the adjustment back to factory setting

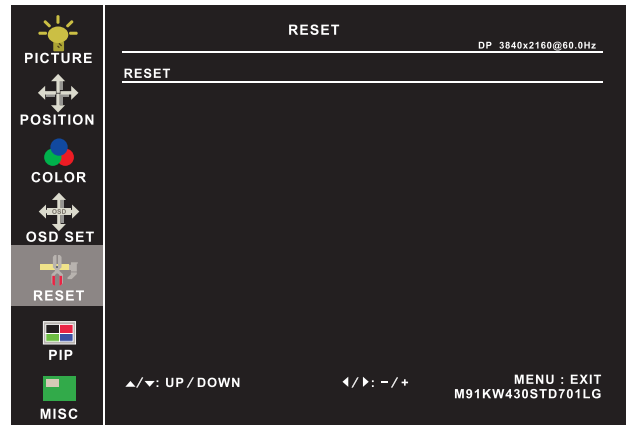

⑥ PIP

PIP mode : Enter into PIP / PBP setting - PIP MODE / PBP 2WIN (Main screen + 1 sub screen) / PBP 3WIN (Main screen + 2 sub screen) / PBP 4WIN (Main screen + 3 sub screen)
Select the signal input of each sub screen

PIP size : Adjust the size of the Sub screen
- Small / Medium / Large / Huge

PIP position : Adjust the position of the Sub screen
- Top Left / Top Right / Bottom Left / Bottom Right

Swap : Swap the input signal of PIP / PBP sub screen

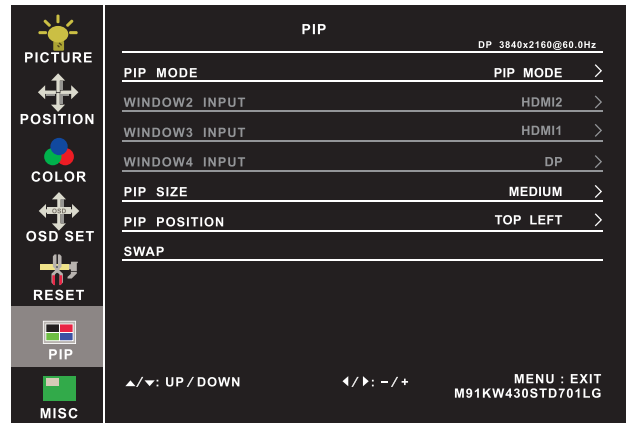

⑦ MISC

Signal source : Select the signal source - DP / HDMI1 / HDMI2

Mute : Turn off the surrounding sound

Audio in : Auto / Line in / DP

Volume : Adjust the volume of sound

Sleep mode : Set the off time - 10 min / 20 min / 30 min / 50 min / 60 min / 120 min / 240 min

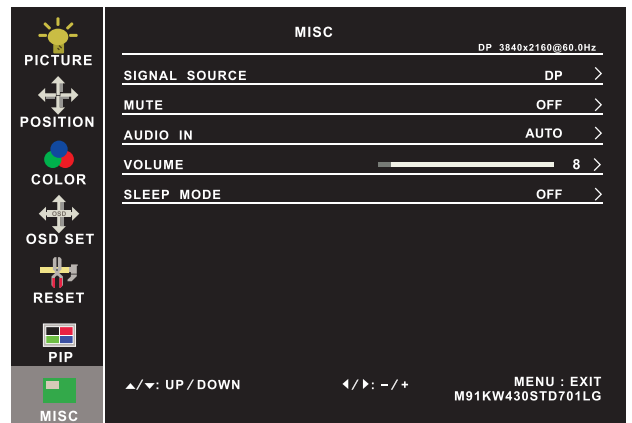

Options on Reset page

Rotation : Rotate the image in Full screen or 1:1
- 90° / 180° / 270°

Picture size : Adjust the image size in Full screen or 1:1

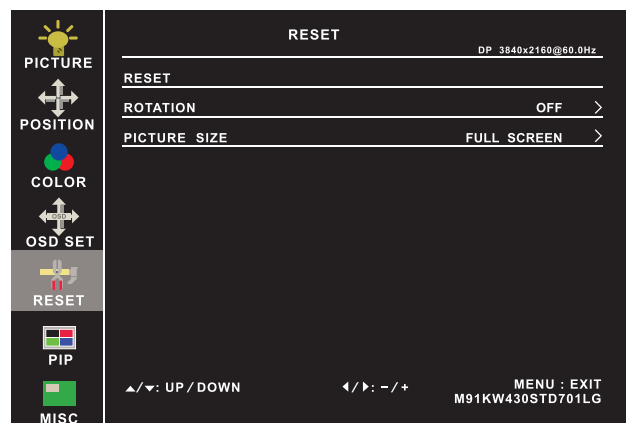

< 4.3 > How to Use Picture In Picture (PIP) / Picture By Picture (PBP)

< 4.3.1 > Picture in Picture (PIP)

Mode

Display the Sub screen in the Main screen.

OSD Menu → MISC → PIP Mode → Large / Small / OFF

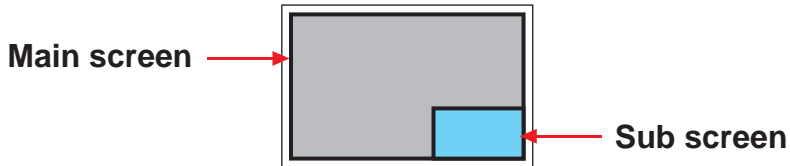

Position

Adjust the position of the Sub screen (top left, bottom left, top right, bottom right)

OSD Menu → MISC → PIP Position → top left / top right / bottom left / bottom right

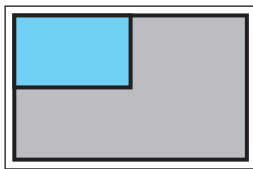

top left

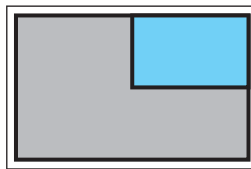

top right

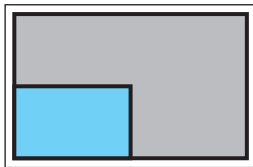

bottom left

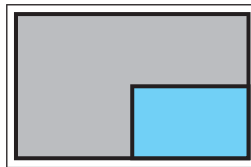

bottom right

Size

Adjust the size of the Sub screen (Large / Small)

OSD Menu → MISC → PIP Mode → Large / Small

Size of Sub screen

| LCD Monitor | Large Sub screen | Small Sub screen |
|-------------|------------------|------------------|
| 1920 x 1200 | 552 x 414 | 480 x 360 |
| 1920 x 1080 | 552 x 414 | 480 x 360 |
| 1440 x 900 | 414 x 310 | 360 x 270 |
| 1366 x 768 | 392 x 294 | 340 x 254 |
| 1280 x 1024 | 368 x 276 | 320 x 240 |

< 4.3 > How to Use Picture In Picture (PIP) / Picture By Picture (PBP)

< 4.3.2 > Picture By Picture (PBP)

Mode

Display the Sub screen next to the Main screen.

OSD Menu → MISC → PIP Mode → PBP



Size

| LCD Monitor | Main / Sub screen |
|-------------|-------------------|
| 1920 x 1200 | 955 x 716 |
| 1920 x 1080 | 955 x 716 |
| 1440 x 900 | 715 x 536 |
| 1366 x 768 | 678 x 508 |
| 1280 x 1024 | 635 x 476 |

< 4.3.3 > PIP / PBP Source

To select an input signal for PIP / PBP Sub screen.

OSD Menu → MISC → PIP Source → HDMI / SDI

The PIP / PBP is operable in the following table :

| Main \ Sub | HDMI | SDI |
|------------|------|-----|
| HDMI | X | O |
| SDI | O | X |

< 5.1 > Option Table

| Options | AP / NAP | DP | OP |
|-------------------------------|----------|----|----|
| Remote controller | ✓ | ✓ | ✓ |
| SDI | ✓ | ✓ | ✓ |
| MCS multi-screen control | ✓ | ✓ | ✓ |
| Touchscreen | ✓ | ✓ | ✓ |
| MIL-type / lockable connector | ✓ | ✓ | ✓ |
| DC Power | ✓ | ✓ | ✓ |

< 5.2 > Remote Controller (RC-2)

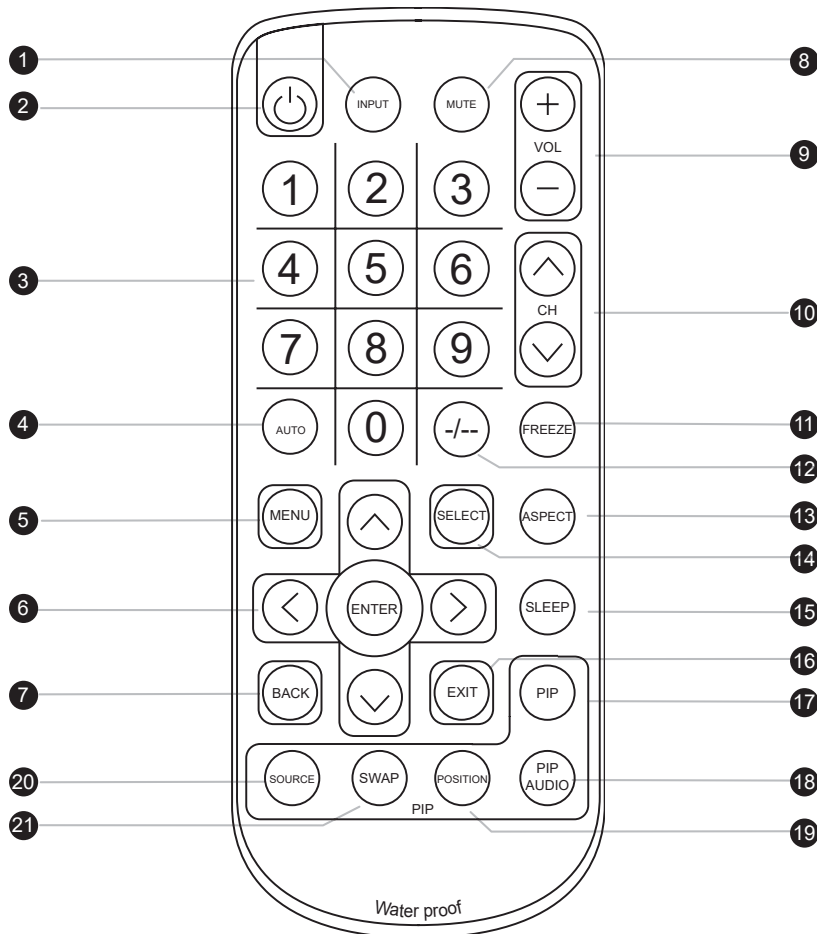

| | | |
|----------------------|------------------------------|--|
| ① | INPUT | Select the source |
| ② | | Switches on or off the TV |
| ③ | 0 - 9 | Only use in TV mode. Select channels. For channel numbers 10 and above, enter the second digit within two seconds. |
| ④ | AUTO | Auto adjust |
| ⑤ | MENU | Display the menu on the screen or go to the previous menu |
| ⑥ | ▲ / ▼ / ◀ / ▶ / ENTER | Go to the upper menu or select the previous value / Go to the next menu or select the next value / Decrease the setting value / Increase the setting value or enter to the select item setting Enter to the select item settings or excude the setting |
| ⑦ | BACK | Back to previous value |
| ⑧ | MUTE | Turn on or off the speaker |
| ⑨ | Vol + / - | Increase or decrease the speaker volume |
| ⑩ | CH + / - | For TV model only, increase or decrease the channel number |
| ⑪ | FREEZE | Reserve for OEM model |
| ⑫ | - / -- | For setting input single or double digits |
| ⑬ | ASPECT | Adjust the screen size |
| ⑭ | SELECT | To select the existing item |
| ⑮ | SLEEP | Select the sleeping time |
| ⑯ | EXIT | Exit the menu or cancel |
| PIP functions | | |
| ⑰ | PIP | Picture in picture |
| ⑱ | PIP AUDIO | To set the audio of in PIP mode |
| ⑲ | POSITION | To set the screen position in PIP mode |
| ⑳ | SOURCE | PIP Source |
| ㉑ | SWAP | Swap screen in PIP mode |



Crystal Image SDI input is an ideal solution for the broadcast-grade video and high resolution CCTV market.

Designed for use with UltraView displays, a SDI input module can support up to 1080p @60Hz resolution without using additional space or power and it comes standard with a 2-year warranty.

SDI

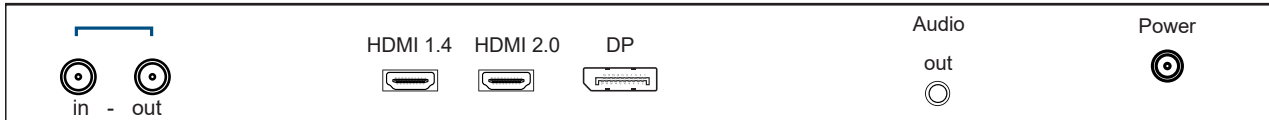

| | | |
|--------------|------------|--|
| INPUT | 3G-SDI IN | BNC x 1 / 0.8Vp-p (75 ohm) |
| | 3G-SDI OUT | BNC x 1 / Active through, equalized & relocked |

| | | |
|----------------------------|-------|---|
| Standard Compliance | Video | SMPTE 425M / 274M / 296M / 125M ITU-R BT.656 |
| | Audio | SMPTE 299M / 272M-C |

| | | |
|--------------------------------|--------------|--|
| Compatible Video Format | 3G-SDI | 1080p @60 / 50Hz, 4:2:2 1080p @30 / 25 / 24Hz, 4:4:4 1080i @60 / 50Hz, 4:4:4 720p @60 / 50Hz, 4:4:4 |
| | HD-SDI | 1080p @30 / 25 / 24Hz, 4:2:2 1080i @60 / 50Hz, 4:2:2 720p @60 / 50Hz, 4:2:2 |
| | SD-SDI | 480i @60Hz, 4:2:2 |
| | ITU-R BT.656 | 576i @50Hz, 4:2:2 |

| | | |
|--------------------------------|--------|---|
| Compatible Audio Format | 3G-SDI | 48kHz, 16 / 20 / 24 bit, 2 CH, Synchronized Video |
| | HD-SDI | 48kHz, 16 / 20 / 24 bit, 2 CH, Synchronized Video |
| | SD-SDI | 48kHz, 16 / 20 / 24 bit, 2 CH, Synchronized / Asynchronized Video |

| | | |
|--|--------|-------------------|
| Max. Transmission Distance 75 ohm coaxial cable | 3G-SDI | 150m at 2.97Gb/s |
| | HD-SDI | 250m at 1.485Gb/s |
| | SD-SDI | 480m at 270Mb/s |

< 5.4 > Options : MCS

MCS (Multi-display Control)

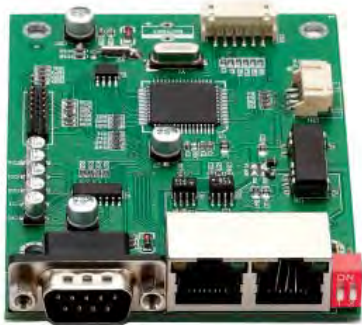

More control is always good. Especially when it is necessary and easy. Crystal Image provides MCS solution to control the **OSD** of various Industrial LCD displays up to 64 units.

The RS-232C is used for the communication between the PC and the first display via a 15 feet serial cable while the CAN bus is used for the various LCD displays cascade together via CAT 5/6 cable, and daisy chain up to 1,000 meters.

Designed for use with LCD displays, Austin Hughes provides a MCS input module without using additional space or power and it comes standard with a 2-year warranty.

MCS

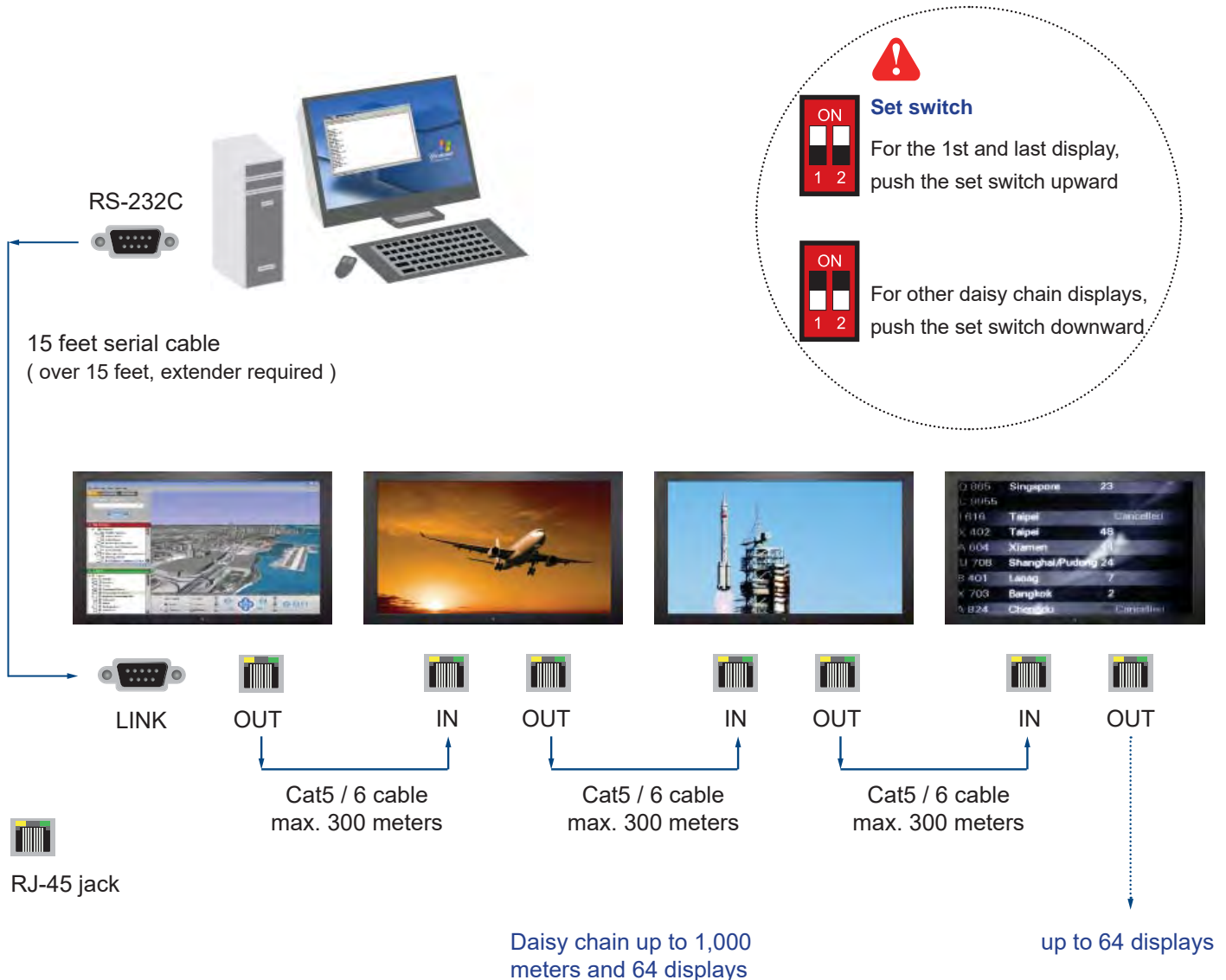
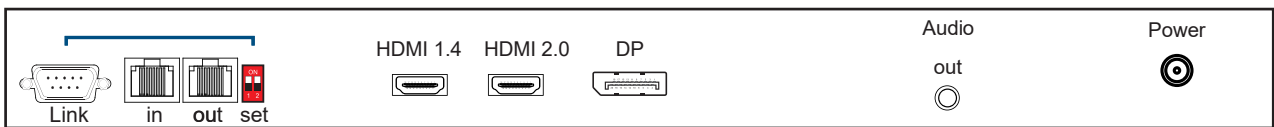



K15" USB Touchscreen Specification

| Model | TPC-10 Multi-touch | TRB e-Resistive |
|----------------------|---------------------------------|-------------------------------|
| Technology | Projected Capacitive | 5-Wire Resistive |
| Touch Point | 10 | Single |
| Input Type | Finger or Capacitive Stylus | Finger or Stylus |
| Resolution | 4096 x 4096 | 2048 x 2048 |
| Touch Point Accuracy | ± 2 mm | - |
| Response Speed | < 5 ms | 15 ms |
| Activation Force | < 5 g | ≤ 50 g |
| Surface Hardness | 6H | 3H |
| Light Transmission | > 85% | 80% ± 3% |
| Haze | 3% ↓ | 8% ± 3% |
| Durability | 50 million touches | 10 million touches |
| Top Layer | 3 mm Glass | ITO Film |
| Bottom Layer | 0.7 mm Sensor Glass | ITO Glass |
| Thickness | 3.9 ± 0.1 mm | 2.2 ± 0.2 mm |
| Connector | USB | USB Type A |
| Compatibility | Linux / Android / Windows / Mac | Windows 7 / XP / Vista, Linux |

- Dimension will be changed if Multi-touch required
- USB touchscreen package includes 1 x 6ft USB cable, quick reference guideline and CD disc
- For detailed information, please refer to the attached CD disc
- As the touchscreen unit is not made of toughened glass, please handle it carefully

USB Touchscreen

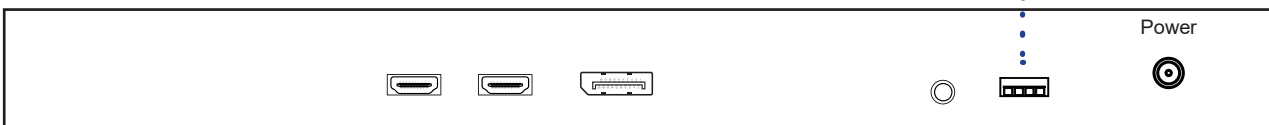

< 5.5 > Options : Touchscreen & driver

K15TPC-10 Driver



Connect the USB cable from the USB port on the LCD to a computer. The touch screen supports easy Plug-and-Play operations. There is no need to install additional drivers on the computer.

TRB Driver

Please follow the below steps to setup the touch screen:-

Step 1. Run the bundled CD disc or download the driver from the link below :

http://www.eeti.com.tw/drivers_Win.html

Step 2. Double click the Setup.exe

Step 3. Follow the installation instruction to finish the setup

Step 4. After installation, run the TouchKit program & the “4 point calibration”



Please do the initial calibration after the first setup

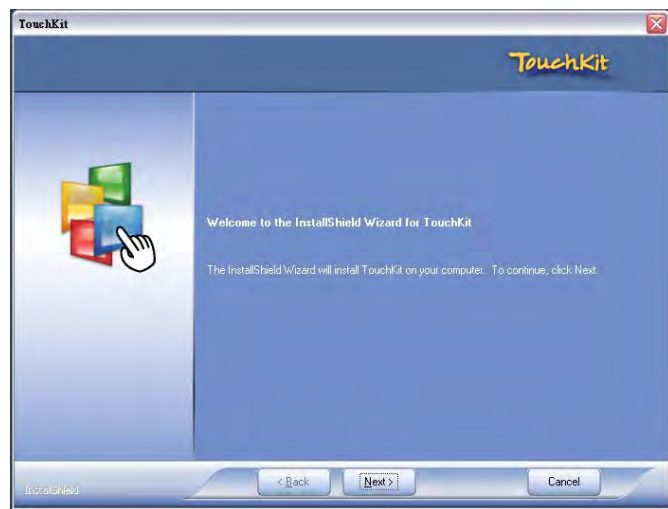

< 5.6 > Options : DC Power



| Model | 12V | 24V | 48V | 125V |
|----------------------|---------|----------|----------|-----------|
| Input rating | | | | |
| Input voltage: | 12-Volt | 24-Volt | 48-Volt | 110-Volt |
| Input range: | 9 ~ 18V | 18 ~ 36V | 36 ~ 75V | 66 ~ 160V |
| Input current | | | | |
| - No load | 50 mA | 50 mA | 50 mA | 35 mA |
| - Full load | 7183 mA | 3551 mA | 1755 mA | 749 mA |
| Output rating | | | | |
| Output voltage: | 12-Volt | 12-Volt | 12-Volt | 12-Volt |
| Output current: | 6.25A | 6.25A | 6.25A | 6.25A |
| Efficiency | 87% | 88% | 89% | 91% |

*** For DC power option :

(1) If the unit with LCD, **earthing** may be required 

| | Input | Part no. | MIL Standard |
|-----------------------------|--------------------------|---|-------------------|
| MIL - type Connector | DC Power *** (Male) | MS3470W8-33P  | MIL - DTL - 26482 |
| | VGA *** (Male) | MS3470W14-15P  | MIL - DTL - 26482 |

*** There are several additional MIL DC and VGA connector types with varying design characteristics to meet cost considerations and to provide users with the most design flexibility possible. For more information, please contact us.

| | Input | Part no. | Standard |
|---------------------------|----------------------|--|------------|
| Lockable Connector | DC Power (Male) | YM-Ext-461CP001  | D-type 3W3 |
| | USB | LUSB - A111 - 00  | - |

*** MIL - type or Lockable connectors above can be integrated with our LCD displays. Sale service just for connectors not provided.

The company reserves the right to modify product specifications without prior notice and assumes no responsibility for any error which may appear in this publication.

All brand names, logo and registered trademarks are properties of their respective owners.